

Carbon Filters – Cartridges & In-Line

AMI Carbon Filters

- Efficient Removal of Chlorine Taste, Odor, and Organic Chemicals
- Fit Most Standard Residential and Commercial Housings
- Ideal for Residential and Commercial Applications
- Competitively Priced
- Extended Life
- Free of Surfactants, Binders & Adhesives

AMI Extruded Carbon Filter Cartridges

- 10 Micron Sediment Filtration (> 98%)
- Uniform Extruded Carbon Core
- No Release of Carbon Fines
- High Dirt-Holding Capacity
- Outer Protective Polypropylene Spunbonded Netting Finish

Model No.	Diameter	Length	For Housing	Micron Rating	Case Qty.
H-F2510AC	2.50"	9.75"	10" Standard	10 μ	20
H-F2520AC	2.50"	20"	20" Standard	10 μ	12
H-F4210AC	4.25"	9.75"	10" Big Blue	10 μ	9
H-F4220AC	4.25"	20"	20" Big Blue	10 μ	9

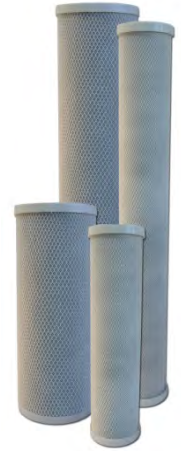

AMI Granular Activated Carbon (GAC) Filter Cartridges

- Granular Activated Carbon in a 10" Filter Cartridge for Standard 10" Filter Housing

Model No.	Diameter	Length	For Housing	Volume of GAC	Case Qty.
H-F2510GAC	2.50"	9.75"	10" Standard	0.56 cu. ft.	24



AMI In-Line Granular Activated Carbon (GAC) Filters

- Granular Activated Carbon in Self-Contained 6" & 10" In-Line Filters
- In-line Installation Eliminates the Need for Additional Housings
- Carbon Type T33 is Ideal for Use as a Post/Polishing Filter

Model No.	Length	Dia.	Connection	Case Qty.
H-F1031-4A	6"	2"	¼" FNPT	50
H-F1032-43A	10"	2"	¼" FNPT	25
H-F1032-43QC	10"	2"	¼" Quick Conn.	25

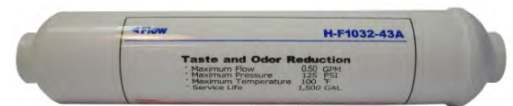

Visit us on the web for our complete product line and in-depth technical information. www.appliedmembranes.com

Sediment Filter Cartridges

AMI Melt-Blown Polypropylene Sediment Filter Cartridges

- Graded Pore Structure Enhances Dirt-Holding Capacity
- Easy and Safe Cartridge Incineration and Disposal
- Free of Surfactants, Binders and Adhesives

Model No.	Micron Rating	Dia.	Length	For Housing	Case Qty.
H-F1001CF	1 μ	2.50"	9.75"	10" Standard	50
H-F1005CF	5 μ	2.50"	9.75"	10" Standard	50
H-F1010CF	10 μ	2.50"	9.75"	10" Standard	50
H-F1020CF	20 μ	2.50"	9.75"	10" Standard	50
H-F1050CF	50 μ	2.50"	9.75"	10" Standard	50
H-F10100CF	100 μ	2.50"	9.75"	10" Standard	50
H-F10BB01CF	1 μ	4.25"	9.75"	10" Big Blue	20
H-F10BB05CF	5 μ	4.25"	9.75"	10" Big Blue	20
H-F2001CF	1 μ	2.50"	20"	20" Standard	25
H-F2005CF	5 μ	2.50"	20"	20" Standard	25
H-F2010CF	10 μ	2.50"	20"	20" Standard	25
H-F2020CF	20 μ	2.50"	20"	20" Standard	25
H-F2050CF	50 μ	2.50"	20"	20" Standard	25
H-F20BB01CF	1 μ	4.25"	20"	20" Big Blue	10
H-F20BB05CF	5 μ	4.25"	20"	20" Big Blue	10
H-F20BB10CF	10 μ	4.25"	20"	20" Big Blue	10
H-F3001CF	1 μ	2.50"	30"	30" Standard	25
H-F3005CF	5 μ	2.50"	30"	30" Standard	25
H-F3010CF	10 μ	2.50"	30"	30" Standard	25
H-F3020CF	20 μ	2.50"	30"	30" Standard	25
H-F4001CF	1 μ	2.50"	40"	40" Standard	20
H-F4005CF	5 μ	2.50"	40"	40" Standard	20
H-F4010CF	10 μ	2.50"	40"	40" Standard	20
H-F4020CF	20 μ	2.50"	40"	40" Standard	20



AMI String Wound Sediment Filter Cartridges

- Enhanced Dirt-Holding Capacity
- Extended Life
- Easy and Safe Cartridge Incineration and Disposal
- Free of Surfactants, Binders and Adhesives

Model No.	Micron Rating	Dia.	Length	For Housing	Case Qty.
H-F1005STR	5 μ	2.50"	9.75"	10" Standard	30
H-F1020STR	20 μ	2.50"	9.75"	10" Standard	30
H-F2005STR	5 μ	2.50"	20"	20" Standard	15
H-F3005STR	5 μ	2.50"	30"	30" Standard	30
H-F4005STR	5 μ	2.50"	40"	40" Standard	15



Visit us on the web for our complete product line and in-depth technical information. www.appliedmembranes.com

Sediment Filters & DI Filters

AMI Pleated Cellulose Poly Sediment Filter Cartridges

- Graded Pore Structure Enhances Dirt-Holding Capacity
- Easy and Safe Cartridge Incineration and Disposal
- Free of Surfactants, Binders and Adhesives

Model No.	Micron Rating	Dia.	Length	For Housing
H-FS105PCAMI	5 μ	2.5"	10"	10" Standard
H-FS205PCAMI	5 μ	2.5"	20"	20" Standard
H-FS10BB5PCAMI	5 μ	4.25"	10"	10" Big Blue
H-FS20BB5PCAMI	5 μ	4.25"	20"	20" Big Blue

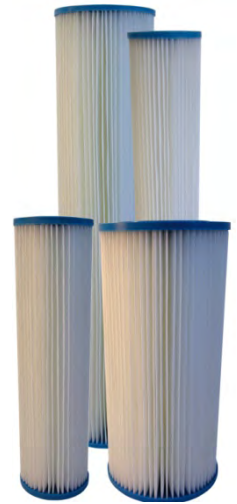

AMI In-Line Sediment Filters

- In-line Installation Eliminates the Need for Additional Housings
- Free of Surfactants, Binders, and Adhesives

Model No.	Micron Rating	Dia.	Length	Connection
H-F1033-40A	5 μ	2"	10"	¼" FNPT



Deionization (DI) Polishing Filter Cartridges

Non-regenerable general purpose deionization polishing cartridges are designed to use as RO Polishers for potable water, or to give multi-megohm quality water for analytical and general laboratory use. The highly purified ion exchange resins will deliver high purity water with a minimum TOC background. Constructed from FDA grade materials and media.

AMI® Filter Cartridges for Deionization (DI)

Model No.	For Use in Housing	Service Flow (GPM)	Capacity for Deionization
H-F2510DI	10" Standard	0.25 to 0.50	7,500 ppm gallons
H-F2520DI	20" Standard	0.50 to 1.00	15,000 ppm gallons
H-F4210DI	10" Big Blue	0.75 to 1.50	22,500 ppm gallons
H-F4220DI	20" Big Blue	1.50 to 3.00	45,000 ppm gallons



AMI® In-Line DI Filters

Model No.	Filter Type	Filter Size	Connection
H-F1035ADI	Mixed Bed DI Resin	2" Dia. x 11"L	¼" Female Threaded
H-F1035ADIC	GAC (1/3) & DI Resin (2/3)	2" Dia. x 11"L	¼" Female Threaded



H-F1035ADI = Blue
H-F1035ADIC = Green

Visit us on the web for our complete product line and in-depth technical information. www.appliedmembranes.com

AMI® FILTERS

Special Purpose Filter Cartridges



Manufactures a wide variety of specialty filters. These filters contain medias which are specially designed to remove specific contaminants from the water. Listed here are the most frequently requested filter types. We are able to supply a wide range of specialty filters. Please contact us with your specific requirements if your filter is not listed below.



AMI® Calcite Filters for pH Neutralization

Raise the pH of RO permeate to make it non-aggressive and compatible with copper piping. Self-Limiting to correct pH only excessive enough to reach a noncorrosive equilibrium.

Model No.	For Use in Housing	Max Flow (GPM)	*Capacity in Gallons of Water Per Amount of Free CO ₂ in Water					
			@ 10ppm	@ 20ppm	@ 30ppm	@ 40ppm	@ 50ppm	@ 60ppm
H-F2510CALCITE	10" Standard	5	8,486	4,243	2,829	2,122	1,697	1,414
H-F2520CALCITE	20" Standard	5	26,737	13,369	8,912	6,684	5,347	4,456
H-F4210CALCITE	10" Big Blue	20	26,737	13,369	8,912	6,684	5,347	4,456
H-F4220CALCITE	20" Big Blue	20	63,937	31,968	21,312	15,984	12,787	10,656

*The table above is an approximate idea of the life of calcite for PH adjustment. The actual value will depend on many factors including the flow rate, water TDS, etc. Use this information as a reference only. **These are not guaranteed values.**

AMI Water Softening Filters

Remove minerals from water through an ion exchange process. Used to prevent hard water scaling and staining, and to prolong the life of RO membranes if used for pretreatment to an RO system.

Model No.	For Use in Housing	Capacity (Grains of Hardness)	Max Flow (GPM)
H-F2510SOFT	10" Standard	750	0.50
H-F2520SOFT	20" Standard	1,500	0.75
H-F4210SOFT	10" Big Blue	2,250	1.50
H-F4220SOFT	20" Big Blue	4,500	2.00

AMI Scale & Corrosion Inhibitor

- Crystalline polyphosphate (slow dissolving) scale inhibitors are used to prevent scaling and precipitation.
- Can be used for: RO pretreatment, ice machines, coffee makers, distillers, hot water heaters, evaporators, steam generators, and more.

Model No.	For Use in Housing	Service Flow (GPM)	Capacity
H-F1099S	10" Standard	0.2 – 0.5 Continuous	25,000+ Gallons

Empty Refillable Cartridges

Model No.	For Use in Housing	Maximum Service Flow (GPM)	Color
C-C2510-EP	10" Standard	5	White Opaque
C-C2510-CLEAR	10" Standard	5	Clear
C-C2520-EP	20" Standard	5	White Opaque
C-C4210-EP	10" Big Blue	20	White w/ Blue End Caps
C-C4220-EP	20" Big Blue	20	White w/ Blue End Caps

Visit us on the web for our complete product line and in-depth technical information. www.appliedmembranes.com



(760) 727-3711 • FX: (760) 727-4427
sales@appliedmembranes.com

AMI®, APPLIED MEMBRANES INC., APPLIED® ARE TRADEMARKS OF APPLIED MEMBRANES, INC. © 2012

MATRIKX[®] CTO[®], VOC[®], and CTO PLUS[®] Filter Cartridges

MATRIKX[®] CTO[®] - Chlorine Taste & Odor Reduction Filters - White End Caps

- Chlorine Taste and Odor Reduction*
- 5 Micron Nominal Filtration for Dirt and Sediment Removal*
- High Adsorptive Capacity and Efficiency*
- Competitively Priced



Model No.	Micron Rating*		Dimensions		For Housing	Chlorine Taste & Odor Reduction Capacity*	Case Qty.
	Nominal	Absolute	Dia.	Length			
32-250-125-050	5 μ	10 μ	2.50"	4.88"	5" Standard	>3,000 gal @ 0.5 gpm	40
32-250-125-975	5 μ	10 μ	2.50"	9.75"	10" Standard	>6,000 gal @ 1 gpm	20
E32-250-125-975**	5 μ	10 μ	2.50"	9.75"	10" Standard	>6,000 gal @ 1 gpm	20
32-250-125-20	5 μ	10 μ	2.50"	20"	20" Standard	>12,000 gal @ 2 gpm	20
32-250-125-29	5 μ	10 μ	2.50"	29"	30" Standard	Not Rated	4
32-250-125-39	5 μ	10 μ	2.50"	39"	40" Standard	Not Rated	4
32-425-125-975	5 μ	10 μ	4.25"	9.75"	10" Big Blue	>12,000 gal @ 3 gpm	9
32-425-125-20	5 μ	10 μ	4.25"	20"	20" Big Blue	>26,000 gal @ 7 gpm	9

*Based on Manufacturer's Internal Testing

**New Economy-Priced CTO Filter! Contact Us for a Quote.

MATRIKX[®] VOC[®] - VOC, Chlorine Taste & Odor Reduction - Green End Caps

- VOC Reduction based on NSF/ANSI Standard 53*
- 0.6 Micron Nominal Filtration for Dirt and Sediment Removal*
- Turbidity Reduction based on NSF/ANSI Standard 53*
- Outstanding Chlorine Taste and Odor Reduction*



Model No.	Micron Rating *		Dimensions		For Housing	Reduction Capacity* (gal)		Case Qty.
	Nominal	Absolute	Dia.	Length		CTO	Chloroform	
02-250-125-050	0.6 μ	2 μ	2.50"	4.88"	5" Standard	Not Rated	Not Rated	40
02-250-125-975	0.6 μ	2 μ	2.50"	9.75"	10" Standard	>6,000 @ 1gpm	>750@0.5gpm	20
02-250-125-20	0.6 μ	2 μ	2.50"	20"	20" Standard	Not Rated	Not Rated	20
02-250-125-29	0.6 μ	2 μ	2.50"	29"	30" Standard	Not Rated	Not Rated	4
02-250-125-39	0.6 μ	2 μ	2.50"	39"	40" Standard	Not Rated	Not Rated	4
02-425-125-975	0.6 μ	2 μ	4.25"	9.75"	10" Big Blue	Not Rated	Not Rated	9
02-425-125-20	0.6 μ	2 μ	4.25"	20"	20" Big Blue	Not Rated	Not Rated	9

*Based on Manufacturer's Internal Testing

MATRIKX[®] CTO[®] Plus - High Capacity Chlorine Taste & Odor Filters - Purple End Caps

- High Chemical Absorptive Capacity*
- 0.6 Micron Nominal Filtration for Dirt and Sediment Removal*
- High VOC Reduction*



Model No.	Micron Rating*		Dimensions		For Housing	Chlorine Taste & Odor Reduction Capacity*	Case Qty.
	Nominal	Absolute	Dia.	Length			
01-250-125-050	0.6 μ	2 μ	2.50"	4.88"	5" Standard	Not Rated	40
01-250-125-975	0.6 μ	2 μ	2.50"	9.75"	10" Standard	>20,000 gal @ 1 gpm	20
01-250-125-20	0.6 μ	2 μ	2.50"	20"	20" Standard	>45,000 gal @ 2 gpm	20
01-250-125-29	0.6 μ	2 μ	2.50"	29"	30" Standard	Not Rated	4
01-250-125-39	0.6 μ	2 μ	2.50"	39"	40" Standard	Not Rated	4
01-425-125-975	0.6 μ	2 μ	4.25"	9.75"	10" Big Blue	>70,000 gal @ 3 gpm	9
01-425-125-20	0.6 μ	2 μ	4.25"	20"	20" Big Blue	>150,000 gal @ 7 gpm	9

*Based on Manufacturer's Internal Testing

Visit us on the web for our complete product line and in-depth technical information. www.appliedmembranes.com



(760) 727-3711 • FX: (760) 727-4427
sales@appliedmembranes.com

AM, APPLIED MEMBRANES INC., APPLIED ARE TRADEMARKS OF APPLIED MEMBRANES, INC. © 2012

MATRIKX[®] PB1[®], CR1[®], and P10[®] Filter Cartridges

MATRIKX[®] PB1[®] - Lead & Cyst Reduction Filter Cartridges - Grey End Caps

- Lead, Cyst and Turbidity Reduction Based on NSF/ANSI Standard 53*
- 0.5 Micron Nominal Filtration for Dirt and Sediment Removal*
- Outstanding Chlorine Taste and Odor Reduction*



Model No.	Micron Rating* (for Sediment Removal)		Filter Dimensions		For Housing	Reduction Capacity*			Case Qty.
	Nominal	Absolute	Dia.	Length		CTO (gal)	Lead (gal)	@ Flow (gpm)	
06-250-125-050	0.5 μ	1 μ	2.50"	4.88"	5" Standard	Not Rated			40
06-250-125-975	0.5 μ	1 μ	2.50"	9.75"	10" Standard	6,000	2,500	0.75	20
06-250-125-20	0.5 μ	1 μ	2.50"	20"	20" Standard	12,000	5,000	1.50	20
06-250-125-29	0.5 μ	1 μ	2.50"	29"	30" Standard	Not Rated			4
06-250-125-39	0.5 μ	1 μ	2.50"	39"	40" Standard	Not Rated			4
06-425-200-975	0.5 μ	1 μ	4.25"	9.75"	10" Big Blue	20,000	8,000	2.50	9
06-425-200-20	0.5 μ	1 μ	4.25"	20"	20" Big Blue	42,000	17,000	5.00	9

*Based on Manufacturer's Internal Testing

MATRIKX[®] CR1[®] - Cyst, Chlorine Taste & Odor Reduction - Yellow End Caps

- 0.5 Micron Nominal Filtration for Dirt and Sediment Removal*
- Cyst Reduction Based on NSF/ANSI Standard 53*
- Turbidity Reduction based on NSF/ANSI Standard 53*
- Outstanding Chlorine Taste and Odor Reduction*



Model No.	Micron Rating* (for Sediment Removal)		Filter Dimensions		For Housing	Chlorine Taste & Odor Reduction Capacity*	Case Qty.
	Nominal	Absolute	Dia.	Length			
19-250-125-050	0.5 μ	1 μ	2.50"	4.88"	5" Standard	Not Rated	40
19-250-125-975	0.5 μ	1 μ	2.50"	9.75"	10" Standard	>10,000 gal @ 2.5 gpm	20
19-250-125-20	0.5 μ	1 μ	2.50"	20"	20" Standard	>20,000 gal @ 5.0 gpm	20
19-250-125-29	0.5 μ	1 μ	2.50"	29"	30" Standard	Not Rated	4
19-250-125-39	0.5 μ	1 μ	2.50"	39"	40" Standard	Not Rated	4

*Based on Manufacturer's Internal Testing

MATRIKX[®] P10[®] - 5M Sediment, Chlorine Taste & Odor Filter - Black End Caps

- 5 Micron Nominal Filtration for Dirt and Sediment Removal*
- High Chlorine Taste and Odor Reduction*
- Efficient Sediment Filter with Large Dirt-Holding Capacity*



Model No.	Micron Rating* (for Sediment Removal)		Filter Dimensions		For Housing	Chlorine Taste & Odor Reduction Capacity*	Case Qty.
	Nominal	Absolute	Dia.	Length			
P10-250-109-096	5 μ	10 μ	2.5"	9.75"	10" Standard	>2,500 gal @ 1.0 gpm	20

*Based on Manufacturer's Internal Testing

Visit us on the web for our complete product line and in-depth technical information. www.appliedmembranes.com

APPLIED MEMBRANES INC.®

ISO 9001:2008
Certified Company

(760) 727-3711 • FX: (760) 727-4427
sales@appliedmembranes.com

AM, APPLIED MEMBRANES INC., APPLIED ARE TRADEMARKS OF APPLIED MEMBRANES, INC. © 2012

Carbon Filter Cartridges

GAC & CC Series Granular Activated Carbon Cartridges

GAC & CC Series cartridges effectively reduce unwanted tastes and odors, including chlorine taste & odor, from drinking water. They are designed to allow maximum contact between the water and carbon, ensuring optimal adsorption. The 20-micron post-filter reduces carbon fines. CC Series contain coconut shell based activated carbon which also reduces VOC and MTBE.



Model No.	Name	Max. Dimensions		For Housing	Chlorine Taste & Odor Reduction Capacity	Case Qty.
		Dia.	Length			
GAC Series Granular Activated Carbon Cartridges						
155110-43	GAC-5	2.88"	4.88"	5" Standard	250 gal @ 0.5 gpm	24
155109-43	GAC-10	2.88"	9.75"	10" Standard	5,000 gal @ 1.0 gpm	12
155111-43	GAC-20	2.88"	20.0"	20" Standard	10,000 gal @ 2.0 gpm	6
155153-43	GAC-BB	4.50"	9.75"	10" Big Blue	12,500 gal @ 2.0 gpm	8
155249-43	GAC20-BB	4.50"	20.0"	20" Big Blue	25,000 gal @ 4.0 gpm	4
CC-10 Coconut Shell Granular Activated Carbon Cartridge						
155155-43	CC-10	2.88"	9.75"	10" Standard	7,500 gal @ 1.0 gpm	12

CBC, EP & EPM Series – Carbon Briquette Filter Cartridges

Carbon Briquette Filter Cartridges are highly effective at reducing unwanted tastes and odors, including chlorine taste & odor from potable drinking water.

- **CBC series** filters offer reduction of Giardia, Cryptosporidium, Entamoeba, and Toxoplasma cysts as well as fine sediment particles down to 0.5 microns.
- **EP & EPM Series** cartridges have a nominal 5-micron filtration rating with high dirt-holding capacity and reduced plugging.
- **CBR2-10** filters reduce lead in addition to chlorine taste & odor.



CBC Series

Model No.	Name	Max. Dimensions		For Housing	Chlorine Taste & Odor Reduction Capacity	Case Qty.
		Dia.	Length			
CBC Series 0.5 Micron Carbon Briquette Filters for Chlorine Taste, Odor & Cyst Reduction						
155169-43	CBC-5	2.88"	4.88"	5" Standard	>3,000 gal @ 1 gpm	24
155162-43	CBC-10	2.88"	9.75"	10" Standard	>20,000 gal @ 2 gpm	12
155309-43	CBC-20	2.88"	20.0"	20" Standard	>45,000 gal @ 2 gpm	12
155170-43	CBC-BB	4.63"	9.75"	10" Big Blue	>50,000 gal @ 2 gpm	4
155312-43	CBC-20BB	4.63"	20.0"	20" Big Blue	>150,000 gal @ 4 gpm	4
EP Series 5 Micron Carbon Briquette Filters for Chlorine Taste & Odor, High Dirt-Holding						
155531-43	EP-10	2.88"	9.75"	10" Standard	>6,000 gal @ 1 gpm	12
155529-43	EP-20	2.88"	20.0"	20" Standard	>12,000 gal @ 2 gpm	6
155698-43	EP-30	2.88"	30"	30" Standard	Not Rated	12
155548-43	EP-BB	4.63"	9.75"	10" Big Blue	>22,000 gal @ 2 gpm	4
155583-43	EP20-BB	4.63"	20.0"	20" Big Blue	>40,000 gal @ 4 gpm	4
EPM Series Economy Priced 5 M Carbon for Chlorine Taste & Odor, High Dirt-Holding						
155634-43	EPM-10	2.88"	9.75"	10" Standard	>3,000 gal @ 1 gpm	24
155635-43	EPM-20	2.88"	20.0"	20" Standard	>6,000 gal @ 2 gpm	6
155782-43	EPM-BB	4.63"	9.75"	10" Big Blue	>15,000 gal @ 2 gpm	4
155783-43	EPM-20BB	4.63"	20.0"	20" Big Blue	>30,000 gal @ 4 gpm	4
CBR2-10 Carbon Briquette Filter for Lead Removal and Chlorine Taste & Odor Reduction						
155268-43	CBR2-10	2.88"	9.75"	10" Standard	20,000 gallons	12



EP & EPM Series

Visit us on the web for our complete product line and in-depth technical information. www.appliedmembranes.com

Carbon Filter Cartridges

C-Series Dual Purpose Powdered-Activated Carbon Cartridges

Constructed of a carbon impregnated cellulose media, these dual-purpose filters provide sediment filtration with a high-dirt holding capacity as well as bad taste & odor, and chlorine taste & odor reduction. Recommended for chlorinated water supplies.

Model No.	Name	Micron Rating	Approx. Dim.		For Housing	Chlorine Taste & Odor Reduction Capacity	Case Qty.
			Dia.	Length			
155022-43	C2	5 μ	2.5"	4.88"	5" Standard	>1,250 gal @ 0.5 gpm	24
155220-43	C8	1 μ	2.5"	9.75"	10" Standard	>5,000 gal @ 1 gpm	24
155002-43	C1	5 μ	2.5"	9.75"	10" Standard	>2,500 gal @ 1 gpm	24
155597-43	C1-20	5 μ	2.5"	20.0"	20" Standard	>5,000 gal @ 2 gpm	14
155651-43	C1-20BB	5 μ	4.5"	20.0"	20" Big Blue	30,000 gallons	6



NCP Series Non-Cellulose Carbon Impregnated Pleated Cartridges

Non-Cellulose media resists bacterial attack allowing them to be used for municipal and non-chlorinated water applications. NCP Series filters provide sediment filtration as well as chlorine taste & odor reduction. Pleated for maximum dirt-loading capacity.

Model No.	Name	Micron Rating	Max. Dim.		For Housing	Chlorine Taste & Odor Reduction Capacity	Case Qty.
			Dia.	Length			
155367-43	NCP-10	10 μ	2.5"	9.75"	10" Standard	225 gal @ 1 gpm	24
155397-43	NCP-20	10 μ	2.5"	20"	20" Standard	450 gal @ 2 gpm	14
155398-43	NCP-BB	10 μ	4.5"	9.75"	10" Big Blue	500 gal @ 2 gpm	8
155382-43	NCP-20BB	10 μ	4.5"	20"	20" Big Blue	1,000 gal @ 2 gpm	6



RFC Series Radial Flow Granular Activated Carbon Cartridges

Ideal for point-of-entry and other high flow applications, RFC series carbon filters provide effective chlorine taste & odor reduction with lower pressure drop.

Model No.	Name	Max. Dimensions		For Housing	Chlorine Taste & Odor Reduction Capacity	Case Qty.
		Dia.	Length			
155065-43	RFC-20	2.75"	20.0"	20" Standard	>6,000 @ 2 gpm	6
155141-43	RFC-BB	4.50"	9.75"	10" Big blue	>35,000 @ 2 gpm	8
155247-43	RFC-20BB	4.50"	20.0"	20" Big Blue	>70,000 @ 4 gpm	6



CCBC Series Coconut Shell Based Granular Activated Carbon Filters

Water-Washed coconut-carbon cartridges are highly effective at reducing unwanted taste and odor and chlorine taste and odor from potable drinking water.

Model No.	Name	Micron Rating	Max. Dim.		For Housing	Chlorine Taste & Odor Reduction Capacity	Cs. Qty.
			Dia.	Length			
155713-43	CCBC-10	1 μ	2.63"	9.75"	10" Standard	>20,000 gal @ 1gpm	12
155714-43	CEP-10E	5 μ	2.63"	9.75"	10" Standard	>5,000 gal @ 1gpm	12



Chlorplus Series Chloramine Reduction Carbon Filter Cartridges

The ChlorPlus® carbon block cartridges offer superior chloramine and chlorine reduction, and have a 1 micron nominal sediment filtration rating.

Model No.	Name	For Housing	Reduction Capacity			Case Qty.
			Chlorine Taste Odor	Chloramine	@ Flow	
255416-43	ChlorPlus 10	10" Standard	>50,000	>1,000	1 gpm	12
255417-43	ChlorPlus 20	20" Standard	>100,000	>2,000	2 gpm	6
355752-43	ChlorPlus BB	10" Big Blue	>250,000	>3,500	2 gpm	4
355753-43	ChlorPlus 20BB	20" Big Blue	>500,000	>7,000	4 gpm	4

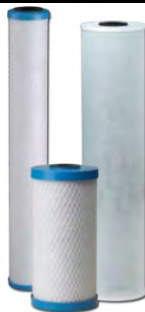

Visit us on the web for our complete product line and in-depth technical information. www.appliedmembranes.com

Sediment Filter Cartridges

CRE-1 Ceramic Filter Cartridge

Specially designed and tested for the reduction of Cryptosporidium and Giardia cysts, ceramic filters are ideal for fine sediment filtration applications. The fine ceramic media will effectively trap dirt, sediment and cysts down to 1-micron in diameter. The ½" thick ceramic wall allows for many cleanings, extending cartridge life.



Model No.	Name	Micron Rating	Max. Dimensions		For Housing	Initial ΔP @ Flow Rate	Case Qty.
			Dia.	Length			
155159-43	CRE-1	1 μ	1.88"	9.75"	10" Standard	19 psi @ 1 gpm	6

P Series Spun-Bonded Polypropylene Cartridges

Manufactured from pure 100% polypropylene and designed for purity and chemical compatibility. Spun fibers form a true gradient density from outer to inner surfaces.



Model No.	Name	Micron Rating	Max. Dimensions		For Housing	Initial ΔP @ Flow Rate	Case Qty.
			Dia.	Length			
155030-43	P5-478	5 μ	2.38"	4.88"	5" Standard	0.3 psi @ 2 gpm	24
155225-43	P1	1 μ	2.38"	9.75"	10" Standard	0.6 psi @ 5 gpm	24
155014-43	P5	5 μ	2.38"	9.75"	10" Standard	0.2 psi @ 5 gpm	24
155015-43	P25	25 μ	2.38"	9.75"	10" Standard	0.2 psi @ 5 gpm	24
155304-43	P1-20	1 μ	2.38"	20.0"	20" Standard	0.6psi @ 10gpm	20
155016-43	P5-20	5μ	2.38"	20.0"	20" Standard	0.6psi @ 10gpm	20
155226-43	P25-20	25μ	2.38"	20.0"	20" Standard	0.2psi @ 10gpm	20
155228-43	P5-30	5 μ	2.38"	30.0"	30" Standard	0.2psi @ 10gpm	20
155224-43	P25-30	25 μ	2.38"	30.0"	30" Standard	0.2psi @ 10gpm	20

WP Series Big Blue Wound Polypropylene Filter Cartridges

WP Series filters are manufactured from a durable polypropylene cord that is wound around a rigid polypropylene core. They are an economical solution to reduce fine sediment including sand, silt, rust and scale particles from a variety of fluids.



Model No.	Name	Micron Rating	Approx. Dimensions		For Housing	Initial ΔP @ Flow Rate	Case Qty.
			Dia	Length			
355212-43	WP.5BB97P	0.5 μ	4.5"	9.75"	10" Big Blue	5 psi @ 10 gpm	8
355213-43	WP1BB97P	1 μ	4.5"	9.75"	10" Big Blue	4 psi @ 15 gpm	8
355214-43	WP5BB97P	5 μ	4.5"	9.75"	10" Big Blue	3 psi @ 20 gpm	8
355215-43	WP10BB97P	10 μ	4.5"	9.75"	10" Big Blue	1 psi @ 20 gpm	8
355216-43	WP25BB97P	25 μ	4.5"	9.75"	10" Big Blue	1 psi @ 20 gpm	8
355222-43	WP1BB20P	1 μ	4.5"	20"	20" Big Blue	6 psi @ 30 gpm	6
355223-43	WP5BB20P	5 μ	4.5"	20"	20" Big Blue	6 psi @ 40 gpm	6
355225-43	WP25BB20P	25 μ	4.5"	20"	20" Big Blue	5 psi @ 30 gpm	6

WPX Series Fibrillated Polypropylene String-Wound

355217-43	WPX5BB97P	5 μ	4.5"	9.75"	10" Big Blue	16 psi @ 10gpm	8
355218-43	WPX10BB97P	10 μ	4.5"	9.75"	10" Big Blue	12 psi @ 15gpm	8
355219-43	WPX25BB97P	25 μ	4.5"	9.75"	10" Big Blue	10 psi @ 20gpm	8
355220-43	WPX50BB97P	50 μ	4.5"	9.75"	10" Big Blue	8 psi @ 30 gpm	8
355221-43	WPX100BB97P	100 μ	4.5"	9.75"	10" Big Blue	8 psi @ 40 gpm	8
355226-43	WPX100BB20P	100 μ	4.5"	20"	20" Big Blue	8 psi @ 65 gpm	6

Visit us on the web for our complete product line and in-depth technical information. www.appliedmembranes.com

Sediment Filter Cartridges

R Series Reusable Pleated Polyester Filter Cartridges

Pleated design maximizes dirt-holding capacity. Versatile and reusable, durable polyester media is bacteria and chemical resistant, allowing for a variety of uses.

Model No.	Name	Micron Rating	Max. Dimensions		For Housing	Initial ΔP @ Flow Rate	Case Qty.
			Dia.	Length			
155031-43	R30-478	30 μ	2.63"	4.88"	5" Standard	<1psi @ 10gpm	24
155017-43	R30	30 μ	2.63"	9.75"	10" Standard	<1psi @ 10gpm	24
155038-43	R50	50 μ	2.63"	9.75"	10" Standard	<1psi @ 10gpm	24
155416-43	R30-20	30 μ	2.63"	20.0"	20" Standard	<1psi @ 10gpm	14
155101-43	R30-BB	30 μ	4.50"	9.75"	10" Big Blue	<1psi @ 10gpm	8
155053-43	R50-BB	50 μ	4.50"	9.75"	10" Big Blue	<1psi @ 10gpm	8
155430-43	R30-20BB	30 μ	4.50"	20.0"	20" Big Blue	<1psi @ 20gpm	6



DGD Series Dual-Gradient Density Filter Cartridges

Designed for purity and chemical compatibility, DGD Series filters are manufactured from pure 100% polypropylene. The larger diameter of the pre-filter reduces the particle load to the post filter, allowing it to operate at higher velocities.

Model No.	Name	Micron Rating		For Housing	Initial ΔP @ Flow Rate	Case Qty.
		Pre-filter	Post filter			
155359-43	DGD-2501	25 μ	1 μ	10" Big Blue	<1 psi @ 10 gpm	8
155357-43	DGD-5005	50 μ	5 μ	10" Big Blue	<1 psi @ 10 gpm	8
155355-43	DGD-7525	75 μ	25 μ	10" Big Blue	<1 psi @ 10 gpm	8
155360-43	DGD-2501-20	25 μ	1 μ	20" Big Blue	<1 psi @ 20 gpm	6
155358-43	DGD-5005-20	50 μ	5 μ	20" Big Blue	<1 psi @ 20 gpm	6
155356-43	DGD-7525-20	75 μ	25 μ	20" Big Blue	<1 psi @ 20 gpm	6



Series S1 Pleated Polyester Cartridges

Pleated design maximizes dirt-holding capacity. Designed for general water filtration purposes. Recommended for chlorinated water supplies. Economically priced.

Model No.	Name	Micron Rating	For Housing	Recommended Flow Rate	Initial ΔP @ Flow Rate	Case Qty.
155001-43	S1	20 μ	10" Standard	12 gpm	2.4psi @ 10gpm	24
155303-43	S1-20	20 μ	20" Standard	15 gpm	0.8psi @ 10gpm	14
155405-43	S1-BB	20 μ	10" Big Blue	20 gpm	1.2psi @ 10gpm	8
155305-43	S1-20BB	20 μ	20" Big Blue	35 gpm	1.2psi @ 10gpm	6



Visit us on the web for our complete product line and in-depth technical information. www.appliedmembranes.com

Sediment Filter Cartridges

Series ECP Cellulose Polyester Cartridges

ECP Series cartridges are manufactured from a special formulation of resin-impregnated cellulose and polyester fibers, providing a higher wet strength than regular cellulose cartridges. It also provides high flow rates and dirt-holding capacity while maintaining extremely low pressure drop.

Model No.	Name	Micron Rating	End Cap Color	Max. Dims.		For Housing	Initial ΔP @ Flow Rate	Case Qty.
				Dia.	Length			
255481-43	ECP1-10	1 μ	Tan	2.63"	9.75"	10" Standard	<1psi@10gpm	24
255482-43	ECP5-10	5 μ	White	2.63"	9.75"	10" Standard	<1psi@10gpm	24
255483-43	ECP20-10	20 μ	Blue	2.63"	9.75"	10" Standard	<1psi@10gpm	24
255484-43	ECP50-10	50 μ	Yellow	2.63"	9.75"	10" Standard	<1psi@10gpm	24
255485-43	ECP1-20	1 μ	Tan	2.63"	20.0"	20" Standard	<1psi@10gpm	14
255486-43	ECP5-20	5 μ	White	2.63"	20.0"	20" Standard	<1psi@10gpm	14
255487-43	ECP20-20	20 μ	Blue	2.63"	20.0"	20" Standard	<1psi@10gpm	14
255488-43	ECP50-20	50 μ	Yellow	2.63"	20.0"	20" Standard	<1psi@10gpm	14
255489-43	ECP1-BB	1 μ	Tan	4.50"	9.75"	10" Big Blue	<1psi@20gpm	8
255490-43	ECP5-BB	5 μ	White	4.50"	9.75"	10" Big Blue	<1psi@20gpm	8
255491-43	ECP20-BB	20 μ	Blue	4.50"	9.75"	10" Big Blue	<1psi@20gpm	8
255492-43	ECP50-BB	50 μ	Yellow	4.50"	9.75"	10" Big Blue	<1psi@20gpm	8
255493-43	ECP1-20BB	1 μ	Tan	4.50"	20.0"	20" Big Blue	<1psi@20gpm	6
255494-43	ECP5-20BB	5 μ	White	4.50"	20.0"	20" Big Blue	<1psi@20gpm	6
255495-43	ECP20-20BB	20 μ	Blue	4.50"	20.0"	20" Big Blue	<1psi@20gpm	6
255496-43	ECP50-20BB	50 μ	Yellow	4.50"	20.0"	20" Big Blue	<1psi@20gpm	6



Polydepth Series Polypropylene Cartridge

Thermally-bonded polypropylene micro-fiber construction for higher filtration efficiency, consistent flow rate, and superior filtration performance.

Model No.	Name	Micron Rating	Max. Dimensions		For Housing	Initial ΔP @ Flow Rate	Case Qty.
			Dia.	Length			
155748-43	PD-1-934	1 μ	2.5"	9.75"	10" Standard	<2 psi @ 2 gpm	24
155749-43	PD-5-934	5 μ	2.5"	9.75"	10" Standard	<2 psi @ 2 gpm	24
155750-43	PD-10-934	10 μ	2.5"	9.75"	10" Standard	<2 psi @ 2 gpm	24
155751-43	PD-25-934	25 μ	2.5"	9.75"	10" Standard	<2 psi @ 2 gpm	24
155752-43	PD-50-934	50 μ	2.5"	9.75"	10" Standard	<2 psi @ 2 gpm	24
155755-43	PD-1-20	1 μ	2.5"	20"	20" Standard	<2 psi @ 5 gpm	14
155756-43	PD-5-20	5 μ	2.5"	20"	20" Standard	<2 psi @ 5 gpm	14
155757-43	PD-10-20	10 μ	2.5"	20"	20" Standard	<2 psi @ 5 gpm	14
155758-43	PD-25-20	25 μ	2.5"	20"	20" Standard	<2 psi @ 5 gpm	14
155759-43	PD-50-20	50 μ	2.5"	20"	20" Standard	<2 psi @ 5 gpm	14
155762-43	PD-1-30	1 μ	2.5"	30"	30" Standard	<2 psi @ 7 gpm	8
155763-43	PD-5-30	5 μ	2.5"	30"	30" Standard	<2 psi @ 7 gpm	8
155765-43	PD-25-30	25 μ	2.5"	30"	30" Standard	<2 psi @ 7 gpm	8
155769-43	PD-1-40	1 μ	2.5"	40"	40" Standard	<2 psi @ 9 gpm	6
155770-43	PD-5-40	5 μ	2.5"	40"	40" Standard	<2 psi @ 9 gpm	6
155772-43	PD-25-40	25 μ	2.5"	40"	40" Standard	<2 psi @ 9 gpm	6



Visit us on the web for our complete product line and in-depth technical information. www.appliedmembranes.com

APPLIED MEMBRANES INC.®

ISO 9001:2008 Certified Company

(760) 727-3711 • FX: (760) 727-4427
sales@appliedmembranes.com

AM, APPLIED MEMBRANES INC., APPLIED ARE TRADEMARKS OF APPLIED MEMBRANES, INC. © 2012

Specialty Filter Cartridges & Bag Filters

RFFE20-BB Iron Reduction Radial Flow Filter Cartridge

Easily and effectively reduces up to 3 ppm of dissolved iron from water, improves flavor and reduces the metallic taste caused by iron, and reduces the possibility of pipe and water heater damage. Should be installed on the main cold water line after the pressure tank or water meter. For best results, pre-sediment & post-carbon treatment is recommended.

Model No.	Name	For Housing
155263-43	RFFE20-BB	20" Big Blue



Approximate Life of Filter:

Iron Level in Water	Total Gallons Water Treated	250 GPD (Four People)	150 GPD (Two People)	75 GPD (One Person)
3 ppm	26,000 gal	104 days	208 days	416 days
2 ppm	40,000 gal	160 days	320 days	640 days
1 ppm	80,000 gal	320 days	640 days	1280 days
0.5 ppm	160,000 gal	640 days	1280 days	n/a

PCF Series Mixed Bed Deionization Cartridges

Designed for deionizing water up to 16 megohms, PCF Series DI Filters are manufactured using an FDA-compliant resin that has been subjected to additional post-production steps to minimize the total organic carbon (TOC) level.

Model No.	Name	Capacity		Suggested Flow Rate	For Housing	Initial ΔP @ Flow Rate
		Grains	mg TDS as CaCO ₃			
155273-43	PCF1-10MB	270	17,500	0.25 gpm	10" Standard	1.5psi @ 0.25gpm
155274-43	PCF1-20MB	600	38,800	0.50 gpm	20" Standard	3.4psi @ 0.50gpm
155281-43	BBF1-20MB	1,850	120,000	1.25 gpm	20" Big Blue	1.1psi @ 1.25gpm



WS Series Water Softener Cartridges

Designed for low water usage, these units will deliver softened product water through the use of FDA-grade sodium based, non-solvent rinsed softening resin. WS Series cartridges utilize single use resin technologies for maximum life grains (CaCo3) capacity.

Model No.	Name	Dimensions		Suggested Flow Rate	For Housing	Capacity (Grains as CaCO ₃)
		Dia.	Length			
155319-43	WS-10	2.6"	9.75"	0.50 gpm	10" Standard	750
155320-43	WS-20	2.6"	20.0"	0.75 gpm	20" Standard	1500
155321-43	WS-20BB	4.5"	20.0"	2.00 gpm	20" Big Blue	4500



BP Series Filter Bags

Glazed polypropylene felt bags are compatible with a broad range of corrosive fluids including organic solvents, oils, acids, alkalis and micro-organisms. Case Qty: 20.

10" Bag Filters

Model No.	Name	Micron Rating
155383-03	BP-410-1	1μ
155385-03	BP-410-5	5 μ
155387-03	BP-410-10	10 μ
155389-03	BP-410-25	25 μ
155391-03	BP-410-50	50 μ
155393-03	BP-410-100	100 μ



20" Bag Filters

Model No.	Name	Micron Rating
155384-03	BP-420-1	1μ
155386-03	BP-420-5	5 μ
155388-03	BP-420-10	10 μ
155390-03	BP-420-25	25 μ
155392-03	BP-420-50	50 μ
155394-03	BP-420-100	100 μ

Visit us on the web for our complete product line and in-depth technical information. www.appliedmembranes.com

Omnipure® Filters – CL Series



Female Threaded “Standard” In-Line Filters

Carbon – T33, T40 & T28 Granular Activated Carbon Filters

- Taste, Odor & Chlorine Reduction
- Ideal for RO or Distillation Units

Model No.	Size (Dia. xL)	Type of Carbon	Volume (Cu. In.)	Service Life (Gallons)	Nominal Rating	In/Out Connections		
						Size	Type	Angle
T33 Acid Washed Granular Activated Carbon – 12x40 Mesh (Post RO)								
CL6ROT33-A	2" x 6"	T33 GAC	8.3	1,000	5 µ	1/8"	FNPT	Straight
CL6ROT33-B	2" x 6"	T33 GAC	8.3	1,000	5 µ	1/4"	FNPT	Straight
CL6ROT33-C	2" x 6"	T33 GAC	8.3	1,000	5 µ	3/8"	FNPT	Straight
CL10ROT33-A	2" x 10"	T33 GAC	16.6	1,500	5 µ	1/8"	FNPT	Straight
CL10ROT33-B	2" x 10"	T33 GAC	16.6	1,500	5 µ	1/4"	FNPT	Straight
CL10ROT33-C	2" x 10"	T33 GAC	16.6	1,500	5 µ	3/8"	FNPT	Straight
T40 Coconut-Shell Based Carbon – 12x40 Mesh (Post RO)								
CL10ROT40-B	2" x 10"	T40 GAC	16.6	1,500	5 µ	1/4"	FNPT	Straight
CL10ROT40-C	2" x 10"	T40 GAC	16.6	1,500	5 µ	3/8"	FNPT	Straight
T28 Granular Activated Carbon – 20x50 Mesh (Pre RO)								
CL6ROT28-B	2" x 6"	T28 GAC	8.3	1,000	5 µ	1/4"	FNPT	Straight
CL6ROT28-C	2" x 6"	T28 GAC	8.3	1,000	5 µ	3/8"	FNPT	Straight
CL10ROT28-A	2" x 10"	T28 GAC	16.6	1,500	5 µ	1/8"	FNPT	Straight
CL10ROT28-B	2" x 10"	T28 GAC	16.6	1,500	5 µ	1/4"	FNPT	Straight
CL10ROT28-C	2" x 10"	T28 GAC	16.6	1,500	5 µ	3/8"	FNPT	Straight



Series CL Filters

- **Uses:** Ice makers, refrigerators, under-the-counter, drinking fountains, beverage equipment, R.O. Systems, and in conjunction with commercial purification systems.

- **In/Out Connections:** Female Threaded

Fitting Size Code:

- A – 1/8"
- B – 1/4"
- C – 3/8"



- **Max. Pressure:** 125 psi
- **Max. Temp.:** 100°F
- **Flow:** Rated at 0.5 GPM
- **Max Service Life:**
Carbon: 1 Year
Sediment: 1 Year
Scale: 6 Months

Sediment Filters

- Polypropylene Depth Filters Remove Dirt, Sand and Sediment
- Protects Down-Line Equipment

Model No.	Size (Dia. xL)	Nominal Filtration Rating (Microns)	In/Out Connections		
			Size	Type	Angle
CL6PF5-A	2" x 6"	5 µ	1/8"	FNPT	Straight
CL6PF5-B	2" x 6"	5 µ	1/4"	FNPT	Straight
CL6PF5-C	2" x 6"	5 µ	3/8"	FNPT	Straight
CL10PF5-A	2" x 10"	5 µ	1/8"	FNPT	Straight
CL10PF5-B	2" x 10"	5 µ	1/4"	FNPT	Straight
CL10PF5-C	2" x 10"	5 µ	3/8"	FNPT	Straight
CL10PF5-PP	2" x 10"	5 µ	1/4"	Male Post	

Scale Inhibitors – GAC & Polyphosphate

- Equipment Scaling Protection
- Reduction of Chlorine Taste and Odor

Model No.	Size (Dia. xL)	Media	Volume (Cu. In.)	Service Life (Gallons)	In/Out Connections		
					Size	Type	Angle
SCL10 - GAC and Polyphosphate for Scale Control & Reduction of Chlorine Taste & Odor							
SCL10-A	2" x 10"	GAC/Polyphosphate	16.6	1,250	1/8"	FNPT	Straight
SCL10-B	2" x 10"	GAC/Polyphosphate	16.6	1,250	1/4"	FNPT	Straight
SCL10-C	2" x 10"	GAC/Polyphosphate	16.6	1,250	3/8"	FNPT	Straight
SL10 - Polyphosphate for Scale Control (only)							
SL10-B	2" x 10"	Polyphosphate	16.6	1,250	1/4"	FNPT	Straight
SL10-C	2" x 10"	Polyphosphate	16.6	1,250	3/8"	FNPT	Straight

Visit us on the web for our complete product line and in-depth technical information. www.appliedmembranes.com

APPLIED MEMBRANES INC.®

ISO 9001:2008 Certified Company

(760) 727-3711 • FX: (760) 727-4427
sales@appliedmembranes.com

AM, APPLIED MEMBRANES INC., APPLIED ARE TRADEMARKS OF APPLIED MEMBRANES, INC. © 2012

Quick Connect & High Capacity In-Line Carbon Filters

Carbon – T33, T40 & T28 Granular Activated Carbon Filters

- Taste, Odor & Chlorine Reduction
- Ideal for RO or Distillation Units

Model No.	Size (Dia. xL)	Type of Carbon	Volume (Cu.In.)	Service Life (Gallons)	In/Out Connections		
					Size	Type	Angle
T33 Acid Washed Granular Activated Carbon – 12x40 Mesh (Post RO)							
K2333JJ	2" x 6"	T33 GAC	9.5	1,000	¼"	QC	Straight
K2333KK	2" x 6"	T33 GAC	9.5	1,000	⅜"	QC	Straight
K2333SS	2" x 6"	T33 GAC	9.5	1,000	¼"	QC	90° Elbow
K2533BB	2" x 10"	T33 GAC	18.5	1,500	¼"	FNPT	Straight
K2533JJ	2" x 10"	T33 GAC	18.5	1,500	¼"	QC	Straight
K2533KK	2" x 10"	T33 GAC	18.5	1,500	⅜"	QC	Straight
K2533SS	2" x 10"	T33 GAC	18.5	1,500	¼"	QC	90° Elbow
K2533PP	2" x 10"	T33 GAC	18.5	1,500	¼"	Male Stem	
K5533BB	2.5" x 10"	T33 GAC	28.6	2,000	¼"	FNPT	Straight
K5533JJ	2.5" x 10"	T33 GAC	28.6	2,000	¼"	QC	Straight
K5633BB	2.5" x 12"	T33 GAC	35.5	2,500	¼"	FNPT	Straight
K5633JJ	2.5" x 12"	T33 GAC	35.5	2,500	¼"	QC	Straight
K5633SS	2.5" x 12"	T33 GAC	35.5	2,500	¼"	QC	90° Elbow
T40 Coconut-Shell Based Carbon – 12x40 Mesh (Post RO)							
K2540JJ	2" x 10"	T40 GAC	18.5	1,500	¼"	QC	Straight
T28 Granular Activated Carbon – 20x50 Mesh (Pre RO)							
K2328JJ	2" x 6"	T28 GAC	9.5	1,000	¼"	QC	Straight
K2528JJ	2" x 10"	T28 GAC	18.5	1,500	¼"	QC	Straight
K2528SS	2" x 10"	T28 GAC	18.5	1,500	¼"	QC	90° Elbow
K5328JJ	2.5" x 6"	T28 GAC	14.7	1,250	¼"	QC	Straight
K5528BB	2.5" x 10"	T28 GAC	28.6	2,000	¼"	FNPT	Straight
K5528JJ	2.5" x 10"	T28 GAC	28.6	2,000	¼"	QC	Straight
K5528KK	2.5" x 10"	T28 GAC	28.6	2,000	⅜"	QC	Straight
K5528SS	2.5" x 10"	T28 GAC	28.6	2,000	¼"	QC	90° Elbow
K5628BB	2.5" x 12"	T28 GAC	35.5	2,500	¼"	FNPT	Straight
K5628JJ	2.5" x 12"	T28 GAC	35.5	2,500	¼"	QC	Straight
K5628SS	2.5" x 12"	T28 GAC	35.5	2,500	¼"	QC	90° Elbow

Carbon Block In-Line Filters

- Taste, Odor & Chlorine & Cyst Reduction
- Scale Reduction (Scale/Polyphosphate Filters Only)

Model No.	Size (Dia. xL)	Nominal Micron Rating	Service Life (Gallons)	In/Out Connections		
				Size	Type	Angle
1 Micron Carbon Block Filters						
K2320BB	2" x 6"	1 μ	1,000	¼"	FNPT	Straight
K2320JJ	2" x 6"	1 μ	1,000	¼"	QC	Straight
K2320KK	2" x 6"	1 μ	1,000	⅜"	QC	Straight
K2520BB	2" x 10"	1 μ	1,500	¼"	FNPT	Straight
K2520JJ	2" x 10"	1 μ	1,500	¼"	QC	Straight
K5520BB	2.5" x 10"	1 μ	2,500	¼"	FNPT	Straight
K5520JJ	2.5" x 10"	1 μ	2,500	¼"	QC	Straight
K5620BB	2.5" x 12"	1 μ	3,000	¼"	FNPT	Straight
1 Micron Carbon & Scale Filters – Carbon Block with Polyphosphate						
K5520PBB	2.5" x 12"	1 μ	2,000	¼"	FNPT	Straight
K5520PJJ	2.5" x 12"	1 μ	2,000	¼"	QC	Straight



Series K Filters

Uses: R.O. Systems, icemakers, under-the-counter, drinking fountains, beverage equipment, refrigerators, and in conjunction with commercial purification systems.

In/Out Connection Types:

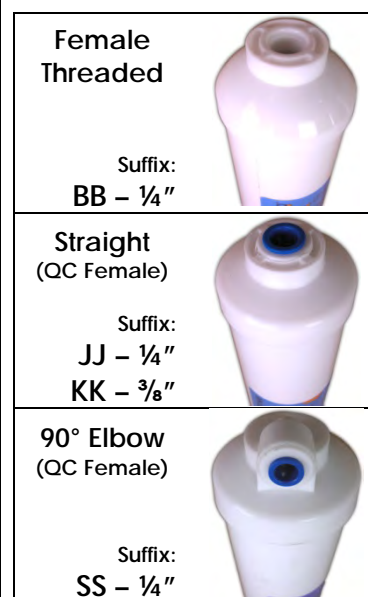

Visit us on the web for our complete product line and in-depth technical information. www.appliedmembranes.com

Quick Connect & High Capacity In-Line Carbon Filters

Carbon Block In-Line Filters

- Taste, Odor & Chlorine Reduction
- Class 1 Particulates Filtration Media
- Cyst Reduction & Lead Reduction (1Micron Lead-Specific Filters Only)
- Max Service Life: One Year

Model No.	Size (Dia. x L)	Nominal Micron Rating	Service Life (Gallons)	In/Out Connections		
				Size	Type	Angle
1 Micron Carbon Block with Lead Specific Media						
K2515JJ	2" x 10"	1 µ	750	¼"	QC	Straight
K5515BB	2.5" x 10"	1 µ	1,250	¼"	FNPT	Straight
K5515JJ	2.5" x 10"	1 µ	1,250	¼"	QC	Straight
K5615BB	2.5" x 12"	1 µ	1,500	¼"	FNPT	Straight
K5615JJ	2.5" x 12"	1 µ	1,500	¼"	QC	Straight
5 Micron Carbon Block Filters						
K5522BB	2.5" x 10"	5 µ	2,500	¼"	FNPT	Straight
K5622BB	2.5" x 12"	5 µ	3,000	¼"	FNPT	Straight
10 Micron Carbon Block Filters						
K2521BB	2" x 10"	10 µ	1,500	¼"	FNPT	Straight
K2521JJ	2" x 10"	10 µ	1,500	¼"	QC	Straight
K2521KK	2" x 10"	10 µ	1,500	¾"	QC	Straight
K5521BB	2.5" x 10"	10 µ	2,500	¼"	FNPT	Straight
K5521JJ	2.5" x 10"	10 µ	2,500	¼"	QC	Straight
K5621BB	2.5" x 12"	10 µ	3,000	¼"	FNPT	Straight
K5621JJ	2.5" x 12"	10 µ	3,000	¼"	QC	Straight

Scale Inhibitors – GAC & Polyphosphate

- Scale Reduction: Equipment Scaling Protection
- Taste, Odor & Chlorine Reduction
- Class 1 Particulates Filtration Media
- Max Service Life: 6 Months

Model No.	Size (Dia. x L)	Volume (Cu.In.)	Service Life (Gallons)	In/Out Connections		
				Size	Type	Angle
K2386JJ	2" x 6"	9.5	750	¼"	QC	Straight
K2386KK	2" x 6"	9.5	750	¾"	QC	Straight
K2586JJ	2" x 10"	18.5	1,250	¼"	QC	Straight
K2586JJ-2oz	2" x 10"	18.5	1,250	¼"	QC	Straight
K2586JJ-4oz	2" x 10"	18.5	1,250	¼"	QC	Straight
K2586BB	2" x 10"	18.5	1,250	¼"	FNPT	Straight
K2586BB-6oz	2" x 10"	18.5	1,250	¼"	FNPT	Straight
K5586BB	2.5" x 10"	28.6	1,500	¼"	FNPT	Straight
K5586CC	2.5" x 10"	28.6	1,500	¾"	FNPT	Straight
K5586JJ	2.5" x 10"	28.6	1,500	¼"	QC	Straight
K5586KK	2.5" x 10"	28.6	1,500	¾"	QC	Straight
K5686BB	2.5" x 12"	35.5	2,000	¼"	FNPT	Straight
K5686JJ	2.5" x 12"	35.5	2,000	¼"	QC	Straight
K5686KK	2.5" x 12"	35.5	2,000	¾"	QC	Straight
Polyphosphate Only – For Scale Control (No GAC)						
K2385JJ	2" x 6"	9.5	n/a	¼"	QC	Straight



Series K Filters

Uses: R.O. Systems, icemakers, under-the-counter, drinking fountains, beverage equipment, refrigerators, and in conjunction with commercial purification systems.

In/Out Connection Types:

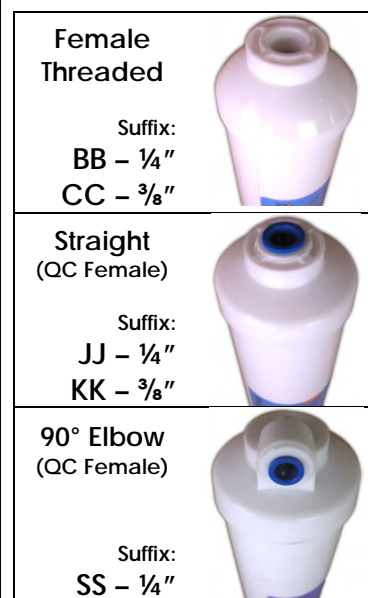

Visit us on the web for our complete product line and in-depth technical information. www.appliedmembranes.com

Sediment & Specialty Media In-Line Filters

Sediment Filters – Block Media Sediment Reduction

- Polypropylene Depth Filtration for Reduction as Small as 5 Microns

Model No.	Size (Dia. xL)	Nominal Micron Rating	In/Out Connections		
			Size	Type	Angle
K2305CC	2" x 6"	5 μ	3/8"	FNPT	Straight
K2305JJ	2" x 6"	5 μ	1/4"	QC	Straight
K2305KK	2" x 6"	5 μ	3/8"	QC	Straight
K2505JJ	2" x 10"	5 μ	1/4"	QC	Straight
K2505SS	2" x 10"	5 μ	1/4"	QC	90° Elbow
K5505BB	2.5" x 10"	5 μ	1/4"	FNPT	Straight
K5505JJ	2.5" x 10"	5 μ	1/4"	QC	Straight
K5605BB	2.5" x 12"	5 μ	1/4"	FNPT	Straight
K5605JJ	2.5" x 12"	5 μ	1/4"	QC	Straight
K5605SS	2.5" x 12"	5 μ	1/4"	QC	90° Elbow



GAC with KDF-55

- Taste, Odor & Chlorine Reduction
- Enhanced Performance and Extended Capacity
- * Marked filters are ALL-KDF (no GAC)

Model No.	Size (Dia. xL)	Volume (Cu.In.)	Service Life (Gallons)	In/Out Connections		
				Size	Type	Angle
K2350BB	2" x 6"	9.5	1,000	1/4"	FNPT	Straight
K2350CC	2" x 6"	9.5	1,000	3/8"	FNPT	Straight
K2356JJ*	2" x 6"	9.5	1,000	1/4"	QC	Straight
K2556JJ*	2" x 10"	18.5	1,500	1/4"	QC	Straight
K2567BB	2" x 10"	18.5	1,500	1/4"	FNPT	Straight
K2567BB-1M	2" x 10"	18.5	1,500	1/4"	FNPT	Straight
K2567JJ	2" x 10"	18.5	1,500	1/4"	QC	Straight
K2567KK	2" x 10"	18.5	1,500	3/8"	QC	Straight
K5567BB	2.5" x 10"	28.6	2,000	1/4"	FNPT	Straight
K5567BB-1M	2.5" x 10"	28.6	2,000	1/4"	FNPT	Straight
K5668BB	2.5" x 12"	35.5	2,500	1/4"	FNPT	Straight
K5668CC	2.5" x 12"	35.5	2,500	3/8"	FNPT	Straight

Series K Filters

Uses: R.O. Systems, icemakers, under-the-counter, drinking fountains, beverage equipment, refrigerators, and in conjunction with commercial purification systems.

Connection Types:

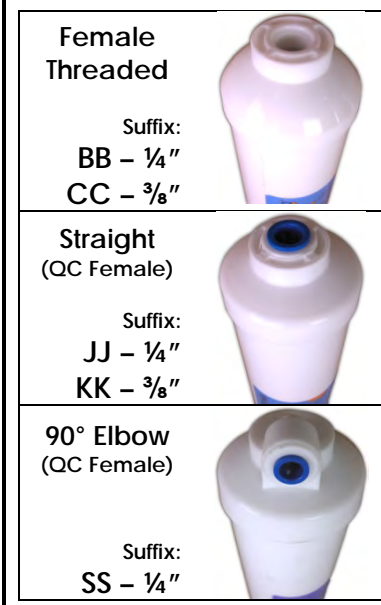

Nitrate Removal Filters

Model No.	Size (Dia. xL)	Volume (Cu.In.)	Capacity	In/Out Connections		
				Size	Type	Angle
K2553BB	2" x 10"	18.5	110 Grains	1/4"	FNPT	Straight
K2553JJ	2" x 10"	18.5	110 Grains	1/4"	QC	Straight
K2553KK	2" x 10"	18.5	110 Grains	3/8"	FNPT	Straight
K5553BB	2.5" x 10"	28.6	165 Grains	1/4"	QC	Straight
K5553JJ	2.5" x 10"	28.6	165 Grains	1/4"	QC	Straight

Visit us on the web for our complete product line and in-depth technical information. www.appliedmembranes.com

DI & Specialty Media In-Line Filters

Deionizing (DI) Mixed Bed Polishing Cartridges

- Ion Exchange Process for Ultra-High Purity Water with a Minimum TOC Background
- Ideal for Polishing RO Product Water

Model No.	Size (Dia. x L)	Volume (Cu.In.)	Capacity	In/Out Connections		
				Size	Type	Angle
K2555BB	2" x 10"	18.5	150 Grains	¼"	FNPT	Straight
K5555BB	2.5" x 10"	28.6	230 Grains	¼"	FNPT	Straight
K5555JJ	2.5" x 10"	28.6	230 Grains	¼"	QC	Straight
K5655BB	2.5" x 12"	35.5	270 Grains	¼"	FNPT	Straight
K5655JJ	2.5" x 12"	35.5	270 Grains	¼"	QC	Straight
NRW37 – Nuclear Grade Mixed Bed Ion Exchange Resin Filters						
K562JJ-NRW37	2" x 10"	18.5	150 Grains	¼"	QC	Straight
K5555BB-NRW37	2.5" x 10"	35.5	270 Grains	¼"	FNPT	Straight
K5655BB-NRW37	2.5" x 12"	35.5	270 Grains	¼"	FNPT	Straight
K5655JJ-NRW37	2.5" x 12"	35.5	270 Grains	¼"	QC	Straight
K5655SS-NRW37	2.5" x 12"	35.5	270 Grains	¼"	QC	90° Elbow



Series K Filters

Uses: R.O. Systems, icemakers, under-the-counter, drinking fountains, beverage equipment, refrigerators, and in conjunction with commercial purification systems.

Silver Impregnated Carbon Filters

Model No.	Size (Dia. x L)	Volume (Cu.In.)	Service Life (Gallons)	In/Out Connections		
				Size	Type	Angle
K2530BB	2" x 10"	18.5	1,500 gal	¼"	FNPT	Straight
K2530KK	2" x 10"	18.5	1,500 gal	⅜"	FNPT	Straight
K5530BB	2.5" x 10"	28.6	2,000 gal	¼"	FNPT	Straight
K5530JJ	2.5" x 10"	28.6	2,000 gal	¼"	QC	Straight
K5630BB	2.5" x 12"	35.5	2,500 gal	¼"	FNPT	Straight
K5630JJ	2.5" x 12"	35.5	2,500 gal	¼"	QC	Straight
K5630CC	2.5" x 12"	35.5	2,500 gal	⅜"	FNPT	Straight

Calcite (Neutralization) Filters

- Neutralize Acidic or Low pH Waters to a Neutral, Less Corrosive Effluent

Model No.	Size (Dia. x L)	Volume (Cu.In.)	In/Out Connections		
			Size	Type	Angle
K2548BB	2" x 10"	18.5	¼"	FNPT	Straight
K2548JJ	2" x 10"	18.5	¼"	QC	Straight

Softening Resin Filters

- Cation Exchange Softening Filters Remove Hardness, Calcium & Scale

Model No.	Size (Dia. x L)	Volume (Cu.In.)	In/Out Connections		
			Size	Type	Angle
K5654BB	2" x 12"	35.5	¼"	FNPT	Straight
K5654JJ	2" x 12"	35.5	¼"	QC	Straight

Connection Types:

Female Threaded

Suffix:

BB – ¼"

CC – ⅜"



Straight (QC Female)

Suffix:

JJ – ¼"

KK – ⅜"



Visit us on the web for our complete product line and in-depth technical information. www.appliedmembranes.com

APPLIED MEMBRANES INC.®

ISO 9001:2008 Certified Company

(760) 727-3711 • FX: (760) 727-4427
sales@appliedmembranes.com

AM, APPLIED MEMBRANES INC., APPLIED ARE TRADEMARKS OF APPLIED MEMBRANES, INC. © 2012

Omnipure® Filters – Q Series



Twist-Off Quick Change Filters

Carbon – T33, T40 & T28 Granular Activated Carbon Filters

- Taste, Odor & Chlorine Reduction
- Maximum Service Life: One Year
- 2.5" Diameter, Fit VH & NVH Filter Heads

Model No.	Filter Length	Type of Carbon	Volume (Cu.In.)	Service Life (Gallons)
T33 Acid Washed Granular Activated Carbon – 12x40 Mesh (Post RO)				
Q5333	6"	T33 GAC	14.7	1,250 gal
Q5433	8"	T33 GAC	21.6	1,500 gal
Q5533	10"	T33 GAC	28.6	2,000 gal
Q5633	12"	T33 GAC	35.5	2,500 gal
Q5733	14"	T33 GAC	41.0	3,000 gal
T40 Coconut-Shell Based Carbon – 12x40 Mesh (Post RO)				
Q5540	10"	T40 GAC	28.6	2,000 gal
Q5640	12"	T40 GAC	35.5	2,500 gal
T28 Granular Activated Carbon – 20x50 Mesh (Pre RO)				
Q5328	6"	T28 GAC	14.7	1,250 gal
Q5428	8"	T28 GAC	21.6	1,500 gal
Q5528	10"	T28 GAC	28.6	2,000 gal
Q5628	12"	T28 GAC	35.5	2,500 gal
Q5728	14"	T28 GAC	41.0	3,000 gal

1 Micron Carbon Block Filters

- Taste, Odor & Chlorine Reduction
- Class 1 Particulates Filtration Media
- Cyst Reduction
- Lead Reduction & Scale Inhibitor Models Available
- Maximum Service Life: One Year
- 2.5" Diameter, Fit VH & NVH Filter Heads

Model No.	Filter Length	Nominal Filtration Rating	Service Life (Gallons)
1 Micron Carbon Block Filters with Cyst Reduction			
Q5320	6"	1µ Particulate & Cyst Reduction	1,500 gal
Q5420	8"	1µ Particulate & Cyst Reduction	2,000 gal
Q5520	10"	1µ Particulate & Cyst Reduction	2,500 gal
Q5620	12"	1µ Particulate & Cyst Reduction	3,000 gal
Q5720	14"	1µ Particulate & Cyst Reduction	3,500 gal
1 Micron Carbon Block Filters with Scale Inhibitor (Polyphosphate) & Cyst Reduction			
Q5420-P	8"	1µ Cyst Reduction & Scale Inhibitor	2,000 gal
Q5520-P	10"	1µ Cyst Reduction & Scale Inhibitor	2,500 gal
1 Micron Carbon Block Filters with Lead and Cyst Reduction			
Q5315	6"	1µ with Lead & Cyst Reduction	750 gal
Q5415	8"	1µ with Lead & Cyst Reduction	1,000 gal
Q5515	10"	1µ with Lead & Cyst Reduction	1,250 gal
Q5615	12"	1µ with Lead & Cyst Reduction	1,500 gal
1 Micron Carbon Block Filters with Lead and Cyst Reduction and Scale Inhibitor			
Q5415-P	8"	1µ Lead, Cyst & Scale	1,000 gal
Q5515-P	10"	1µ Lead, Cyst & Scale	1,250 gal
Q5615-P	12"	1µ Lead, Cyst & Scale	1,500 gal
Q5715-P	14"	1µ Lead, Cyst & Scale	2,000 gal



Series Q Filters

Filter bodies twist directly on/off the filter heads for fast and easy replacement. No housings or replaced fittings.

Uses: R.O. Systems, icemakers, under-the-counter, drinking fountains, beverage equipment, refrigerators, and in conjunction with commercial purification systems.

Filter Heads



Model No.	In/Out Connections
Valved "Twist-Tap" Filter Heads	
VH1/4	¼" Female Threaded
VH1/4-JG	¼" Quick Connect
VH3/8	⅜" Female Threaded
Non-Valved Filter Heads	
NVH1/4	¼" Female Threaded
NVH1/4-JG	¼" Quick Connect
NVH3/8	⅜" Female Threaded

Visit us on the web for our complete product line and in-depth technical information. www.appliedmembranes.com

APPLIED MEMBRANES INC.®

ISO 9001:2008
Certified Company

(760) 727-3711 • FX: (760) 727-4427
sales@appliedmembranes.com

AM, APPLIED MEMBRANES INC., APPLIED ARE TRADEMARKS OF APPLIED MEMBRANES, INC. © 2012

Omnipure® Filters – Q Series



Twist-Off Quick Change Filters

10 Micron Carbon Block Filters

- Taste, Odor & Chlorine Reduction
- Class 1 Particulates Filtration
- Maximum Service Life: One Year
- 2.5" Diameter, Fit VH & NVH Filter Heads

Model No.	Filter Length	Nominal Filtration Rating	Service Life (Gallons)
10 Micron Carbon Block Filters			
Q5321	6"	10µ	1,500 gal
Q5421	8"	10µ	2,000 gal
Q5521	10"	10µ	2,500 gal
Q5621	12"	10µ	3,000 gal
Q5721	14"	10µ	3,500 gal
10 Micron Carbon Block Filters with Scale Inhibitor (Polyphosphate)			
Q5321-P	6"	10µ w/ Scale Inhibitor	1,000 gal
Q5421-P	8"	10µ w/ Scale Inhibitor	1,600 gal
Q5621-P	12"	10µ w/ Scale Inhibitor	2,500 gal
Q5721-P	14"	10µ w/ Scale Inhibitor	3,000 gal

Scale Inhibitors – GAC with Polyphosphate

- Taste, Odor & Chlorine Reduction
- Scale Inhibitor for Equipment Scaling Protection
- 2.5" Diameter, Fit VH & NVH Filter Heads
- Maximum Service Life: 6 Months

Model No.	Filter Length	Media Type	Volume (Cu.In.)	Service Life (Gallons)
Q5386	6"	GAC & Polyphosphate	14.7	1,000 gal
Q5486	8"	GAC & Polyphosphate	21.6	1,250 gal
Q5586	10"	GAC & Polyphosphate	28.6	1,500 gal
Q5686	12"	GAC & Polyphosphate	35.5	2,000 gal
Q5786	14"	GAC & Polyphosphate	41.0	2,500 gal
Polyphosphate Only – For Scale Control (No GAC)				
Q5385	6"	Polyphosphate Only	14.7	n/a
Q5485	8"	Polyphosphate Only	21.6	n/a
Q5785	14"	Polyphosphate Only	41.0	n/a

Sediment Filters – Block Media Sediment Reduction

- Polypropylene Depth Filtration
- Protects Down-Line Equipment
- 2.5" Diameter, Fit VH & NVH Filter Heads

5 Micron Nominal Filtration

Model No.	Filter Length
Q5305	6"
Q5405	8"
Q5505	10"
Q5605	12"
Q5705	14"

25 Micron Nominal Filtration

Model No.	Filter Length
Q5325	6"
Q5425	8"
Q5625	12"

Specialty Medias in Q Series Filter Bodies

- 2.5" Diameter, Fit VH & NVH Filter Heads

Model No.	Filter Length	Media Type	Volume (Cu.In.)	Service Life/ Capacity
Softening Filters, for Removal of Minerals through an Ion Exchange Process				
Q5554-C100E	10"	Softening Resin	28.6	600 Grains
Q5654-C100E	12"	Softening Resin	35.5	750 Grains
Q5754-C100E	14"	Softening Resin	41.0	900 Grains
GAC with KDF, For Enhanced Taste, Odor & Chlorine Reduction				
Q5467	8"	T33 GAC & KDF	21.6	1,500 Gallons
Q5567	10"	T33 GAC & KDF	28.6	2,000 Gallons
Mixed bed Deionizing (DI) Polishing Filters				
Q5655	12"	Mixed Bed DI Resin	35.5	270 Grains
Q5562	10"	NRW-37 DI Resin	28.6	220 Grains

Visit us on the web for our complete product line and in-depth technical information. www.appliedmembranes.com

APPLIED MEMBRANES INC.®

ISO 9001:2008 Certified Company

(760) 727-3711 • FX: (760) 727-4427
sales@appliedmembranes.com

AM®, APPLIED MEMBRANES INC., APPLIED® ARE TRADEMARKS OF APPLIED MEMBRANES, INC. © 2012

Omnipure® Filters – E Series



“Universal” Replacement Filter Bodies

Carbon – T33, T40 & T28 Granular Activated Carbon Filters

- Taste, Odor & Chlorine Reduction.
- Maximum Service Life: One Year
- 2.5” Diameter, “Universal Style” for Use with Existing Permanent Head Installations

Model No.	Filter Length	Type of Carbon	Volume (Cu.In.)	Service Life (Gallons)
T33 Acid Washed Granular Activated Carbon – 12x40 Mesh (Post RO)				
E5333	6”	T33 GAC	14.7	1,250
E5433	8”	T33 GAC	21.6	1,500
E5533	10”	T33 GAC	28.6	2,000
E5633	12”	T33 GAC	35.5	2,500
E5733	14”	T33 GAC	41.0	3,000
T28 Granular Activated Carbon – 20x50 Mesh (Pre RO)				
E5328	6”	T28 GAC	14.7	1,250
E5428	8”	T28 GAC	21.6	1,500
E5528	10”	T28 GAC	28.6	2,000
E5628	12”	T28 GAC	35.5	2,500
E5728	14”	T28 GAC	41.0	3,000

1 Micron Carbon Block Filters

- Taste, Odor & Chlorine Reduction with Cyst Reduction
- Class 1 Particulates Filtration Media
- Lead Reduction & Scale Inhibitor Models Available
- Maximum Service Life: One Year
- 2.5” Diameter, “Universal Style” for Use with Existing Permanent Head Installations

Model No.	Filter Length	Nominal Filtration Rating	Service Life (Gallons)
1 Micron Carbon Block Filters with Cyst Reduction			
E5320	6”	1µ Particulate & Cyst Reduction	1,500 gal
E5420	8”	1µ Particulate & Cyst Reduction	2,000 gal
E5520	10”	1µ Particulate & Cyst Reduction	2,500 gal
E5620	12”	1µ Particulate & Cyst Reduction	3,000 gal
E5720	14”	1µ Particulate & Cyst Reduction	3,500 gal
1 Micron Carbon Block Filters with Scale Inhibitor (Polyphosphate) & Cyst Reduction			
E5320-P	6”	1µ Cyst Reduction & Scale Inhibitor	1,500 gal
E5420-P	8”	1µ Cyst Reduction & Scale Inhibitor	2,000 gal
E5520-P	10”	1µ Cyst Reduction & Scale Inhibitor	2,500 gal
E5620-P	12”	1µ Cyst Reduction & Scale Inhibitor	3,000 gal
E5720-P	14”	1µ Cyst Reduction & Scale Inhibitor	3,500 gal
1 Micron Carbon Block Filters with Lead and Cyst Reduction			
E5515	10”	1µ with Lead & Cyst Reduction	1,250 gal
E5615	12”	1µ with Lead & Cyst Reduction	1,500 gal
E5715	14”	1µ with Lead & Cyst Reduction	2,000 gal
1 Micron Carbon Block Filters with Lead & Cyst Reduction and Scale Inhibitor			
E5415-P	8”	1µ Lead, Cyst & Scale	1,000 gal
E5515-P	10”	1µ Lead, Cyst & Scale	1,250 gal
E5615-P	12”	1µ Lead, Cyst & Scale	1,500 gal
E5715-P	14”	1µ Lead, Cyst & Scale	2,000 gal
1 Micron Carbon Block Filters with KDF			
E5520-K	10”	1µ Cyst Reduction & KDF	2,500 gal
E5620-K	12”	1µ Cyst Reduction & KDF	3,000 gal



Series E Filters

Replacement filter body engineered with a universal cap designed to affix to existing permanent heads. This series offers similar performance to existing replacement bodies on the market but is offered at a lower price.

Ideal for use in commercial beverage and food service applications.

Visit us on the web for our complete product line and in-depth technical information. www.appliedmembranes.com

APPLIED MEMBRANES INC.®

**ISO 9001:2008
Certified Company**

(760) 727-3711 • FX: (760) 727-4427
sales@appliedmembranes.com

AM, APPLIED MEMBRANES INC., APPLIED ARE TRADEMARKS OF APPLIED MEMBRANES, INC. © 2012

Omnipure® Filters – E Series



“Universal” Replacement Filter Bodies

10 Micron Carbon Block Filters

- Taste, Odor & Chlorine Reduction
- Class 1 Particulates Filtration
- Maximum Service Life: One Year
- 2.5” Diameter, “Universal Style” for Use with Existing Permanent Head Installations

Model No.	Filter Length	Nominal Filtration Rating	Service Life (Gallons)
<i>10 Micron Carbon Block Filters</i>			
E5321	6”	10μ	1,500 gal
E5421	8”	10μ	2,000 gal
E5521	10”	10μ	2,500 gal
E5621	12”	10μ	3,000 gal
E5721	14”	10μ	3,500 gal
<i>10 Micron Carbon Block Filters with Scale Inhibitor (Polyphosphate)</i>			
E5321-P	6”	10μ w/ Scale Inhibitor	1,000 gal
E5421-P	8”	10μ w/ Scale Inhibitor	2,000 gal
E5521-P	10”	10μ w/ Scale Inhibitor	2,500 gal
E5621-P	12”	10μ w/ Scale Inhibitor	2,500 gal
E5721-P	14”	10μ w/ Scale Inhibitor	3,000 gal

Scale Inhibitors – GAC with Polyphosphate

- Taste, Odor & Chlorine Reduction
- Scale Inhibitor for Equipment Scaling Protection
- Maximum Service Life: 6 Months
- 2.5” Diameter, “Universal Style” for Use with Existing Permanent Head Installations

Model No.	Filter Length	Media Type	Volume (Cu.In.)	Service Life (Gallons)
E5386	6”	GAC & 2 Oz. Polyphosphate	14.7	1,000 gal
E5486	8”	GAC & 2 Oz. Polyphosphate	21.6	1,250 gal
E5586	10”	GAC & 3 Oz. Polyphosphate	28.6	1,500 gal
E5686	12”	GAC & 4 Oz. Polyphosphate	35.5	2,000 gal
E5786	14”	GAC & 4 Oz. Polyphosphate	41.0	2,500 gal
<i>Polyphosphate Only – For Scale Control (No GAC)</i>				
E5385	6”	Polyphosphate Only	14.7	n/a
E5485	8”	Polyphosphate Only	21.6	n/a
E5585	10”	Polyphosphate Only	28.6	n/a
E5685	12”	Polyphosphate Only	35.5	n/a
E5785	14”	Polyphosphate Only	41.0	n/a

Sediment Filters – Block Media Sediment Reduction

- Polypropylene Depth Filtration
- Protects Down-Line Equipment
- 2.5” Diameter, “Universal Style” for Use with Existing Permanent Head Installations

Model No.	Filter Length	Nominal Filtration Rating
E5305	6”	5μ
E5405	8”	5μ
E5505	10”	5μ
E5605	12”	5μ
E5705	14”	5μ

Mixed Bed Deionization (DI) Polishing Filters

- Ion Exchange Process for Ultra-High Purity Water with a Minimum TOC background
- Ideal for Polishing RO Product Water
- 2.5” Diameter, “Universal Style” for Use with Existing Permanent Head Installations

Model No.	Filter Length	Media Type	Volume (Cu.In.)	Service Capacity
E5455	8”	Mixed Bed DI Resin	21.6	160 Grains
E5555	12”	Mixed Bed DI Resin	28.6	220 Grains
E5655	10”	Mixed Bed DI Resin	35.5	270 Grains

Visit us on the web for our complete product line and in-depth technical information. www.appliedmembranes.com

APPLIED MEMBRANES INC.®

**ISO 9001:2008
Certified Company**

(760) 727-3711 • FX: (760) 727-4427
sales@appliedmembranes.com

AM, APPLIED MEMBRANES INC., APPLIED ARE TRADEMARKS OF APPLIED MEMBRANES, INC. © 2012

High Capacity Filters & Filter Cartridges

ELF Series “Large Format” High Capacity Filter Bodies

- Higher Flow Rates and Expanded Volume capacity
- Two-Piece Bayonet-Style Replaceable Body and Permanent Head
- 3.5” Dia. x 10” Length Large Format Filters
(ELFXL Series Extra Large Format 3.5” Dia. x 15” Length filters available upon request)

Model No.	Description	Nominal Rating	Service Life (Gallons)	Flow Rate
ELF Series Carbon Block Filters				
ELF-1M	GAC w/ Cyst Reduction	1µ	15,000 gal	1.67 GPM
ELF-1ML	GAC w/ Lead & Cyst Reduction	1µ	2,500 gal	1.67 GPM
ELF-1ML-KDF	GAC & KDF w/ Lead & Cyst Red.	1µ	2,500 gal	1.67 GPM
ELF-5M	GAC Block	5µ	10,000 gal	1.67 GPM
ELF-10M	GAC Block	10µ	10,000 gal	1.67 GPM

ELF Series Filter Head/Accessories

Model No.	Description
ELF-DK7	Permanent Head for ELF and E Series Filters. Also replaces existing “universal” filter head installations. 3/8” Female NPT in/out conn.
ELF-BRACKET	Bracket for ELF and Q Series Housings. Includes Screws.



Series ELF Filters

Replacement Filter Cartridges by Omnipure

- Fit Standard 10” Filter Housings with Slim Profiles
- Available in Standard Granular Media and Carbon Block Configurations

Model No.	Filter Length	Type of Carbon	Volume (Cu.In.)	Service Life (Gallons)
Granular Activated Carbon Cartridges – OC Series				
OCB934ROT-28	9 3/4”	T28 GAC	56	5,000 gal
OCB934ROT-33	9 3/4”	T33 GAC	56	5,000 gal

Model No.	Filter Length	Type of Carbon	Nominal Micron Rating	Chlorine Reduction
Carbon Block Filter Replacements – OMB Series				
OMB934-1M	9 3/4”	Carbon Block	1µ	>15,000 gal
OMB934-5M	9 3/4”	Carbon Block	5µ	>10,000 gal
OMB934-10M	9 3/4”	Carbon Block	10µ	>10,000 gal



Omnipure Filter Cartridges

Visit us on the web for our complete product line and in-depth technical information. www.appliedmembranes.com

Aqualine[®] Special Purpose Filters

Deionization, Scale, KDF, and Nitrate Filters

Deionization (DI) Filter Cartridges

Non-regenerable general purpose di polishing cartridges are designed to use as RO Polishers for potable water, or to give multi-megohm quality water for analytical and general laboratory use. The highly purified ion exchange resins will deliver high purity water with a minimum TOC background. Media: Semiconductor grade (low TOC) mixed bed ion exchange resins (1:1 equivalent ratio)

- pH Range: 0-14

Model No.	For Use in Housing	Service Flow (GPM)	Capacity for Deionization
DI-4	10" Standard	0.50 GPM	7,500 ppm gallons
DI-4-20	20" Standard	1.00 GPM	15,000 ppm gallons
DI-2*	10" Standard	0.25 GPM	7,500 ppm gallons

*DI-2 is a high-purity deionization cartridge.

Scale & Corrosion Inhibitors

Crystalline polyphosphate (slow dissolving) scale inhibitors are used to prevent scaling and precipitation. Can be used as pretreatment for: RO, Ice Machines, Coffee Makers, Distillers, Hot Water Heaters, Evaporators, Steam Generators, and more.

- pH Range: 6 to 9

Model No.	For Use in Housing	Service Flow (GPM)	Capacity
PS-1	10" Standard	0.2 – 0.5 Continuous	25,000+ Gallons*

*Based on 5 ppm phosphate available for continuous use.

KDF Filter for Chlorine, Lead, and Heavy Metals Removal

Our KDF Filters contain a blend of KDF and high activity de-dusted granular activated carbon to give extremely effective and long life de-chlorination capacity, and can be used anywhere regular GAC's are used. In addition to chlorine removal, KDF filters may be used for the removal of lead and heavy metals. The capacity will be approximately 20% of those listed for chlorine.

- pH Range: 6.5 to 8.5

Model No.	Media	For Use in Housing	Service Flow (GPM)	Chlorine Capacity
KDC+4.0	GAC w/ 4 lbs. KDF	10" Standard	1.0 – 3.0	50,000 Gal*

*Tested on city water spiked to 2.2 ppm chlorine to 10% break. Capacity based on standard conditions. Your results may vary.

Nitrate Removal Filter

The NRC brine regenerable RO polishing will remove virtually all of the nitrates, nitrites and sulphates from tap water or RO product water for approximately 7500 ppm. The NRC is particularly useful as an RO polisher (since membrane rejection of nitrates can be limited) or in waters containing low sulphates. The NRC can be regenerated using sodium chloride brine.

Model No.	For Use in Housing	Service Flow (GPM)	Capacity
NRC	10" Standard	1.0 – 3.0	7,500 ppm gal



Aqualine (Systematix) Filter cartridges incorporate pre and post filter material, are constructed totally of FDA grade materials and media, and are available in 10" & 20" Lengths and Standard & Big Blue Sizes. Please contact AMI for any models or sizes not shown.

Pre-Filter: 100µ reticulated poly foam

Post Filter: 20µ spun-bonded polypropylene

Visit us on the web for our complete product line and in-depth technical information. www.appliedmembranes.com

APPLIED MEMBRANES INC.[®]

**ISO 9001:2008
Certified Company**

(760) 727-3711 • FX: (760) 727-4427
sales@appliedmembranes.com

AMI, APPLIED MEMBRANES INC., APPLIED ARE TRADEMARKS OF APPLIED MEMBRANES, INC. © 2012

AquaPure[®], ScaleStick[®], Replacements

AquaPure, ScaleStick, Everpure & Culligan Replacement

Cuno[®] AquaPure[®] Filter Cartridges

- Fit 10" Standard Filter Housings (Approx. Dimensions: 2 $\frac{5}{8}$ " Dia. x 9 $\frac{3}{4}$ ")
- Progressive Porosity Design Helps Provide Longer Life
- Remove Dirt, Rust, Sand, and Particulates from Water Down to 5 Microns
- Carbon Filters use Specially Formulated High-Absorption Activated Carbon and are Double Action for Sediment, Chlorine Taste and Odor Reduction

Model No.	Description	Micron Rating
AP110	Resin Bonded Cellulose Sediment Filter	5 μ
AP117RO	Granular Activated Carbon + Sediment Filter	5 μ
AP117SE	Single Entry Granular Activated Carbon + Sediment Filter	5 μ
APS117	GAC with Scale Inhibitor + Sediment Filter	5 μ



AP110

AP117

Additional Cuno/AquaPure filters not listed are available by special order.

HydroBlend[™] ScaleStick[™] Scale Inhibitor

HydroBlend is a unique composition blended to provide superior limescale (calcium carbonate) prevention and corrosion control in water fed equipment. The system feeds a controlled amount of specially blended scale control compounds into the water stream. ScaleStick cartridges fit standard 10" filter housings allowing them to be used in existing installations.

Model No.	For Use in Housing	Service Flow (GPM)	Capacity
SS-10	10" Standard	0.1 – 6	2-6,000 gal.



Hydrotech[®] Compatible Filter Replacements

- For Replacement into Hydrotech Reverse Osmosis Systems

Model No.	Description	Micron Rating
41400009	Block Carbon	5 μ
41400008	5 Micron Sediment	5 μ
RS-22-CB5-OMN	Block Carbon – Omnipure Brand	5 μ
RS-22-SED5-OMN	5 Micron – Omnipure Brand	5 μ
RS-22-SED10-OMN	10 Micron Sediment – Omnipure Brand	10 μ



Culligan[®] Compatible Filter Replacements

- For Replacement into Culligan Reverse Osmosis Systems

Model No.	Description	Replaces/Used In	Length
32-175-050-100	Extruded Carbon by KX	AC30/AC15, H83/H5	11.75"
CULLIGAN5M	5 M Sediment by Omnipure	AC30/AC15, H83/H5	10.8"
CULLIGAN10M	Carbon Block by Omnipure	AC30/AC15, H83/H5	10.8"

Visit us on the web for our complete product line and in-depth technical information. www.appliedmembranes.com

APPLIED MEMBRANES INC.[®]

ISO 9001:2008
Certified Company

(760) 727-3711 • FX: (760) 727-4427
sales@appliedmembranes.com

AM[®], APPLIED MEMBRANES INC.[®], APPLIED[®] ARE TRADEMARKS OF APPLIED MEMBRANES, INC. © 2012

Filter Housings & Accessories

10" Standard Filter Housings – for 2-2½" Dia. × 9¾" L Filter Cartridges

- MAX Pressure: 125psi (8.8 kg/cm²); MAX Temperature: 120°F (50°C)

Model No.	For Filters		Color		In/Out (FNPT)	Cap Style	Pressure Relief
	Length	Dia. (Style)	Body	Cap			
H-H14FBE33	10"	Standard	Blue	Black	¼"	Flat	No
H-H14FWW33	10"	Standard	White	White	¼"	Flat	No
H-H14FCE33	10"	Standard	Clear	Black	¼"	Flat	No
H-H38XWW33	10"	Standard	White	White	¾"	Ribbed	No
H-H12XBE33	10"	Standard	Blue	Black	½"	Ribbed	No
H-H12XCE33	10"	Standard	Clear	Black	½"	Ribbed	No
H-H34XBE33	10"	Standard	Blue	Black	¾"	Ribbed	No
H-H34FBE33	10"	Standard	Blue	Black	¾"	Flat	No
H-H34XCE33	10"	Standard	Clear	Black	¾"	Ribbed	No
H-H34FCE33	10"	Standard	Clear	Black	¾"	Flat	No
H-H34FCE33R	10"	Standard	Clear	Black	¾"	Flat	Yes



20" Standard Filter Housings – for 2-2½" Dia. × 20" L Filter Cartridges

- MAX Pressure: 125psi (8.8 kg/cm²); MAX Temperature: 120°F (50°C)

Model No.	For Filters		Color		In/Out (FNPT)	Cap Style	Pressure Relief
	Length	Dia. (Style)	Body	Cap			
H-H212XBE	20"	Standard	Blue	Black	½"	Ribbed	No
H-H212XBER	20"	Standard	Blue	Black	½"	Ribbed	Yes
H-H234WBE	20"	Standard	Blue	Black	¾"	Ribbed	No
H-H234WBER	20"	Standard	Blue	Black	¾"	Ribbed	Yes



Ribbed Cap Flat Cap

10" Big Blue Filter Housings – for 4½" Dia. × 10" L Filter Cartridges

- MAX Pressure: 100psi (7kg/cm²); MAX Temperature: 120°F (50°C); MAX Flux: 50 GPM

Model No.	For Filters		Color		In/Out (FNPT)	Cap Style	Pressure Relief
	Length	Dia. (Style)	Body	Cap			
H-H101BBE	10"	Big Blue	Blue	Black	1"	Ribbed	No
H-H101BBER	10"	Big Blue	Blue	Black	1"	Ribbed	Yes
H-H115BBE	10"	Big Blue	Blue	Black	1½"	Ribbed	No
H-H115BBER	10"	Big Blue	Blue	Black	1½"	Ribbed	Yes

20" Big Blue Filter Housings – for 4½" Dia. × 20" L Filter Cartridges

- MAX Pressure: 90psi (6.3kg/cm²); MAX Temperature: 120°F (50°C); MAX Flux: 50 GPM

Model No.	For Filters		Color		In/Out (FNPT)	Cap Style	Pressure Relief
	Length	Dia. (Style)	Body	Cap			
H-H201BBE	20"	Big Blue	Blue	Black	1"	Ribbed	No
H-H201BBER	20"	Big Blue	Blue	Black	1"	Ribbed	Yes
H-H215BBE	20"	Big Blue	Blue	Black	1½"	Ribbed	No
H-H215BBER	20"	Big Blue	Blue	Black	1½"	Ribbed	Yes

Accessories for Filter Housings

Model No.	Description
155003	Filter Connector for connecting 2.5" Dia. Filters together in series
H-C9200	Wrench for 10" Standard AMI Filter Housings
H-C9203	Wrench for 20" Standard AMI Filter Housings
H-C9205	Wrench for AMI & Pentek Big Blue Housings



Visit us on the web for our complete product line and in-depth technical information. www.appliedmembranes.com

Pentek Filter Housings & Accessories

Pentek® Filter Housings

Model No.	For Filters		Color		In/Out Conn. (FNPT)	Rpl. O-Ring	Pressure Relief
	Length	Dia. (Style)	Body	Cap			
5" Standard Filter Housings – for 2.5"Dia. x 5"L Filter Cartridges							
158002	5"	Standard	Blue	Black	3/8"	151121	No
158138	5"	Standard	Blue	Black	1/4"	151121	No
158203	5"	Standard	Blue	Black	1/2"	151121	No
10" Standard Filter Housings – for 2-2 1/2"Dia. x 9 3/4"L Filter Cartridges							
158008	10"	Standard	Clear	Blue	3/8"	151121	No
158098	10"	Standard	White	White	3/8"	151121	No
158115	10"	Standard	Blue	Black	1/4"	151121	Yes
158125	10"	Standard	White	White	1/4"	151121	No
158182	10"	Standard	White	White	1/4"	151121	Yes
158196	10"	Standard	Blue	Black	1/2"	151121	No
158195	10"	Standard	Blue	Black	1/2"	151121	Yes
150068	10"	Standard	Blue	Black	3/4"	151120	No
20" Standard Filter Housings – for 2-2 1/2"Dia. x 20"L Filter Cartridges							
158129	20"	Standard	Blue	Black	3/8"	151121	No
158204	20"	Standard	Blue	Black	1/2"	151121	Yes
158205	20"	Standard	Blue	Black	1/2"	151121	No
150069	20"	Standard	Blue	Black	3/4"	151120	Yes
150070	20"	Standard	Blue	Black	3/4"	151120	No
10" Big Blue Filter Housings – for 4 1/2"Dia. x 10"L Filter Cartridges							
150469	10"	Big Blue	Blue	Black	3/4"	151122	Yes
150470	10"	Big Blue	Blue	Black	3/4"	151122	No
150237	10"	Big Blue	Blue	Black	1"	151122	Yes
150238	10"	Big Blue	Blue	Black	1"	151122	No
150239	10"	Big Blue	Blue	Black	1 1/2"	151122	Yes
150240	10"	Big Blue	Blue	Black	1 1/2"	151122	No
20" Big Blue Filter Housings – for 4 1/2"Dia. x 20"L Filter Cartridges							
150467	20"	Big Blue	Blue	Black	3/4"	151122	Yes
150468	20"	Big Blue	Blue	Black	3/4"	151122	No
150233	20"	Big Blue	Blue	Black	1"	151122	Yes
150234	20"	Big Blue	Blue	Black	1"	151122	No
150235	20"	Big Blue	Blue	Black	1 1/2"	151122	Yes
150236	20"	Big Blue	Blue	Black	1 1/2"	151122	No



Slim Line 5" to 20"



Big Blue 10" & 20"

Filter Wrenches for Pentek Filter Housings

Model No.	For Use with Housing
150539	Slim Line Housings (5", 10", 20" up to 1/2" Port Size)
150295	Wide Housings (10", 20" Standard, 3/4" Port Size)
150296	10" Big Blue
144368	20" Big Blue



Visit us on the web for our complete product line and in-depth technical information. www.appliedmembranes.com

APPLIED MEMBRANES INC.®

ISO 9001:2008 Certified Company

(760) 727-3711 • FX: (760) 727-4427
sales@appliedmembranes.com

AM, APPLIED MEMBRANES INC., APPLIED ARE TRADEMARKS OF APPLIED MEMBRANES, INC. © 2012

Commercial Filter Housings

Bag Vessels, Stainless Steel, and FRP Housings

Pentek® Bag Filter Vessels

- Come Complete with Gauge, Wrench, and 3/8" Drain Valve

Model No.	Model Name	For Filter Bag	Connection	Max. Dimensions	Max. Pressure
150360	PBH-410-1	10"	1" NPT	13 ⁵ / ₈ " x 7 ¹ / ₄ "	100 psi
150338	PBH-410-1.5	10"	1 ¹ / ₂ " NPT	13 ⁵ / ₈ " x 7 ¹ / ₄ "	100 psi
150367	PBH-420-1	20"	1" NPT	23 ³ / ₈ " x 7 ¹ / ₄ "	90 psi
150337	PBH-420-1.5	20"	1 ¹ / ₂ " NPT	23 ³ / ₈ " x 7 ¹ / ₄ "	90 psi

PBH-410 accepts a standard 4" x 8¹/₄" bag. Dimensions allow for 1" overlap on basket.

PBH-420 accepts a standard 4" x 18¹/₂" bag. Dimensions allow for 1" overlap on basket.



Shelco® Stainless Steel Multi-Filter Housings

- Constructed of 304 Stainless Steel (316SS available upon request) with Poly-Coat Finish and FDA Grade Buna-N Gasket
- Pressure Rated at 150 psi @ 300°F
- 4FOS to 22FOS come standard with Band Clamp Closure, Swing-Bolt Closure available upon request. 36FOS & 56FOS come in Swing-Bolt Only
- Housings will accept filters up to 2³/₄" OD and in the following lengths as specified:
 - 10"=(9³/₄" or 10") • 20"=(19¹/₂" or 20") • 30"=(29¹/₄" or 30") • 40"=(39" or 40")



Model No.	Houses Filters		Max Flow (GPM)	Pipe Size
	Qty.	Length		
4FOS1	4	10"	28	2" MNPT
4FOS2	4	20"	56	2" MNPT
4FOS3	4	30"	84	2" MNPT
4FOS4	4	40"	112	2" MNPT
5FOS1	5	10"	35	2" MNPT
5FOS2	5	20"	70	2" MNPT
5FOS3	5	30"	105	2" MNPT
5FOS4	5	40"	140	2" MNPT
7FOS1	7	10"	49	2" MNPT
7FOS2	7	20"	98	2" MNPT
7FOS3	7	30"	147	2" MNPT
7FOS4	7	40"	196	2" MNPT

Model No.	Houses Filters		Max Flow (GPM)	Pipe Size
	Qty.	Length		
12FOS2	12	20"	168	3" Flange
12FOS3	12	30"	252	3" Flange
12FOS4	12	40"	336	3" Flange
22FOS3	22	30"	462	4" Flange
22FOS4	22	40"	616	4" Flange
36FOS3	36	30"	540	6" Flange
36FOS4	36	40"	720	6" Flange
56FOS3	56	30"	780	6" Flange
56FOS4	56	40"	1,040	6" Flange

*Also available in 316SS – add "316" to the end of the part # to order. Example: 4FOS1-316

Eden Excel® FRP Filter Housings

- Designed to ASME Code, Section X Standards
- Maximum Use Pressure: 150 PSI at 150° F
- Corrosion Resistance: Compatible with Fluids in the PH Range of 2-13

Model No.	Houses Filters		Max Flow (GPM)	Pipe Size
	Qty	Length		
6EFC1-2C150	6	10"	30	2" NPT
12EFC1-2C150	6	20"	60	2" NPT
18EFC1-2C150	6	30"	90	2" NPT
24EFC1-2C150	6	40"	120	2" NPT

Model No.	Houses Filters		Max Flow (GPM)	Pipe Size
	Qty	Length		
20EFC2-3C150	10	20"	100	3" NPT
30EFC2-3C150	10	30"	150	3" NPT
40EFC2-3C150	10	40"	200	3" NPT
50EFC2-3C150	10	50"	250	3" NPT



Visit us on the web for our complete product line and in-depth technical information. www.appliedmembranes.com

APPLIED MEMBRANES INC.®

ISO 9001:2008 Certified Company

(760) 727-3711 • FX: (760) 727-4427
sales@appliedmembranes.com

AM, APPLIED MEMBRANES INC., APPLIED ARE TRADEMARKS OF APPLIED MEMBRANES, INC. © 2012

AMI® Commercial Filter Housings

Stainless Steel Multi-Cartridge Filter Housings

AMI® Commercial Stainless Steel Multi-Cartridge Filter Housings provide a high quality solution for high-volume filtering at reduced pricing. Ideal for use in chemical systems, pre-filtration, high purity water, post-filtration and more, these housings will fit standard 30" or 40" filter cartridges.

Industry Applications

- Reverse Osmosis Pretreatment
- Chemical & Petrochemical
- Dairy
- Drinking Water
- Food and Beverage
- Liquid Desalination
- Electronics
- Fuel Material Extraction
- Pharmaceuticals & Biotechnology
- Pulp & Paper
- Wastewater Reuse
- Recycled Water
- Industrial Water Treatment

Features and Specifications

- Band V-Clamp Top Closure for Quick and Easy Cartridge Replacement
- Side-In and Side-Out Connections
- Available with Threaded or Flanged Fittings for Easy Installation
- Housings are Compatible with Standard 2.5" OD, 30" & 40" Length Melt-Blown or Wound Polypropylene Filter Cartridges
- Materials of Construction:
 - 316L Stainless Steel with Electropolish Finish
 - Buna-N O-Ring
- Operating Limits:
 - Maximum Operating Pressure: 150 psi (10 bar)
 - Maximum Operating Temperature: 250°F (120°C)



Design & Ordering Information

Model No.	Maximum Flow*		Houses Cartridges†		Inlet/ Outlet	Vent	Drain
	gpm	m³/hr	Qty.	Length			
C-0530-2F-316LEP	105	23.8	5	30"	2" Flange	¼" NPT	½" NPT
C-0530-2T-316LEP	105	23.8	5	30"	2" MNPT	¼" NPT	½" NPT
C-0730-2F-316LEP	147	33.4	7	30"	2" Flange	¼" NPT	½" NPT
C-0730-2T-316LEP	147	33.4	7	30"	2" MNPT	¼" NPT	½" NPT
C-0740-2F-316LEP	196	44.5	7	40"	2" Flange	¼" NPT	½" NPT
C-0740-2T-316LEP	196	44.5	7	40"	2" MNPT	¼" NPT	½" NPT
C-1230-3F-316LEP	252	57.2	12	30"	3" Flange	¼" NPT	½" NPT
C-1240-3F-316LEP	336	76.2	12	40"	3" Flange	¼" NPT	½" NPT
C-2230-4F-316LEP	462	104.9	22	30"	4" Flange	¼" NPT	½" NPT
C-2240-4F-316LEP	616	139.8	22	40"	4" Flange	¼" NPT	½" NPT

*Maximum flow shown is based on 7 gpm per 10" filter typical clean filter with DP of less than 3 psi. Flow rates are for guide lines only. Actual flow rates will vary based on fluid, viscosity, cartridge type, micron ratings and other factors.

†Housing will accept standard 2.5" OD Filter cartridges in the following lengths: 30"=(29¼" or 30") or 40"=(39" or 40")

Visit us on the web for our complete product line and in-depth technical information. www.appliedmembranes.com

APPLIED MEMBRANES INC.®

**ISO 9001:2008
Certified Company**

(760) 727-3711 • FX: (760) 727-4427
sales@appliedmembranes.com

AMI®, APPLIED MEMBRANES INC., APPLIED® ARE TRADEMARKS OF APPLIED MEMBRANES, INC. © 2012

AMI® Commercial Filter Housings

Stainless Steel Multi-Cartridge Filter Housings

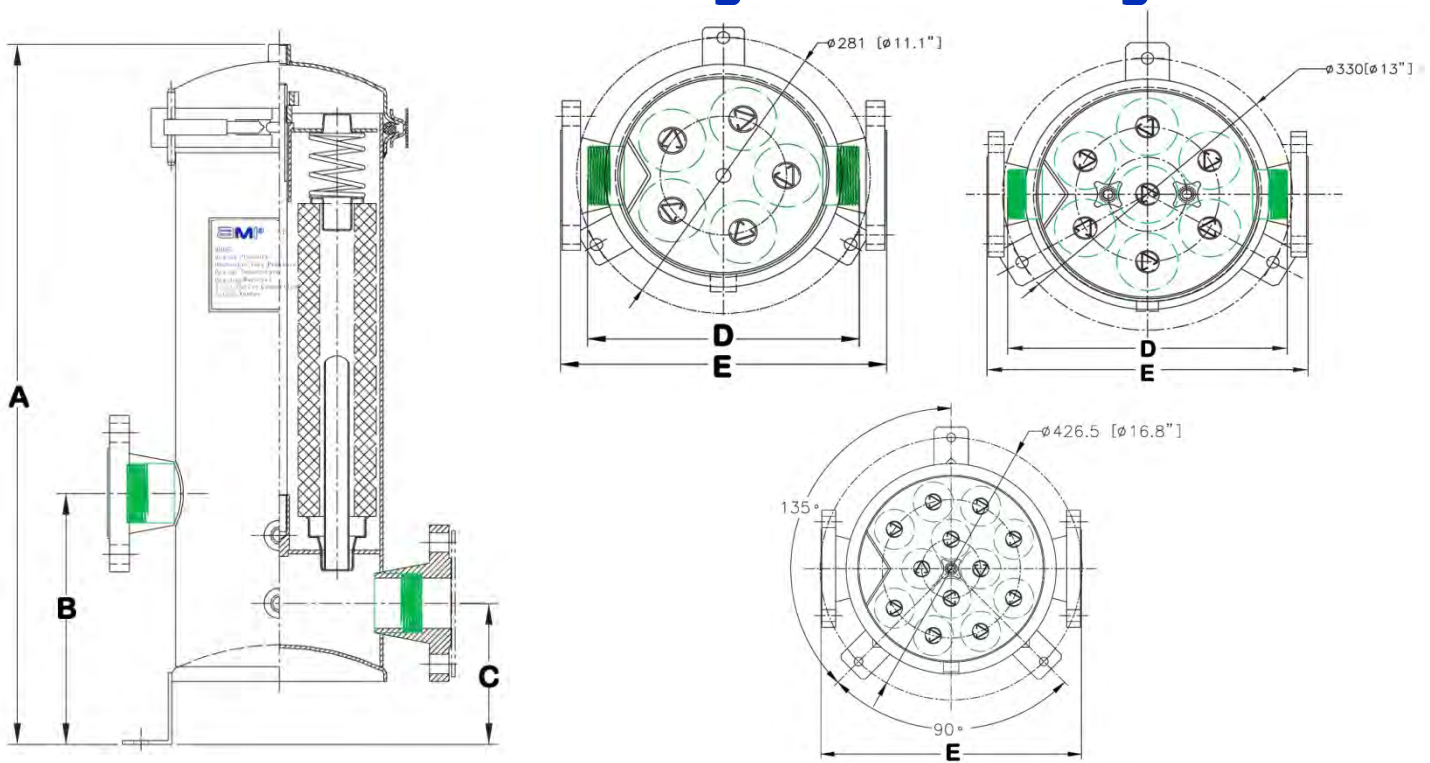

Installation Dimensions

Model No.	Houses Cartridges		Installation Dimensions									
	Qty.	Length	A		B		C		D		E	
			in	mm	in	mm	in	mm	in	mm	in	mm
C-0530-2F-316LEP	5	30"	43.7	1111	9.5	242	5.5	140	10.2	260	12.0	305
C-0530-2T-316LEP	5	30"	43.7	1111	9.5	242	5.5	140	10.2	260	12.0	305
C-0730-2F-316LEP	7	30"	45.1	1145	10.6	269	5.8	148	12.4	316	14.4	366
C-0730-2T-316LEP	7	30"	45.1	1145	10.6	269	5.8	148	12.4	316	14.4	366
C-0740-2F-316LEP	7	40"	55.1	1399	10.6	269	5.8	148	12.8	326	14.6	370
C-0740-2T-316LEP	7	40"	55.1	1399	10.6	269	5.8	148	12.8	326	14.6	370
C-1230-3F-316LEP	12	30"	51.3	1303	15.1	384	9.8	248	n/a	n/a	16.7	424
C-1240-3F-316LEP	12	40"	61.3	1557	15.1	384	9.8	248	n/a	n/a	16.7	424
C-2230-4F-316LEP	22	30"	52.0	1321	15.2	387	9.5	241	n/a	n/a	21.0	533
C-2240-4F-316LEP	22	40"	62.0	1575	15.2	387	9.5	241	n/a	n/a	21.0	533

Dimensions are approximate for reference only.



Visit us on the web for our complete product line and in-depth technical information. www.appliedmembranes.com

APPLIED MEMBRANES INC.®

**ISO 9001:2008
Certified Company**

(760) 727-3711 • FX: (760) 727-4427
sales@appliedmembranes.com

AMI®, APPLIED MEMBRANES INC., APPLIED® ARE TRADEMARKS OF APPLIED MEMBRANES, INC. © 2012

Stainless Steel Multi-Cartridge Filter Housings

Applications

- Reverse Osmosis Pre-Filtration
- Residential and Commercial Drinking Water
- Cooling Tower Filtration
- Process Water
- Ground Water Remediation
- Utility Water
- Industrial Waste Water Treatment
- Surface Water Treatment Rule (SWTR) II

Harmsco HIF Series Up-Flow Multi-Cartridge Housings

- 304 Stainless Steel Electro-Polished (316SS option available*)
- Fail-Safe Lids with Individual Studs and Bronze Wing Nuts
- CPVC Standpipe for Up-Flow Design
- Pressure Rated at 150 PSI



Certified to
ANSI-NSF 61

Model No.	Max Flow (GPM)	# of Cartridges		Inlet/Outlet	Drain	Dimensions	
		Single	Alternate Config.			Height	Width
HIF-7	30	7	n/a	1½" NPT	1" NPT	19½"	13"
HIF-14	60	14	7 Double	1½" NPT	1" NPT	28"	13"
HIF-16	75	16	8 Double	2" NPT	1" NPT	28"	13"
HIF-21	90	21	7 Triple	1½" NPT	1" NPT	37"	13"
HIF-24	105	24	8 Triple	2" NPT	1" NPT	37"	13"
HIF-42	175	42	14 Triple	2" NPT	1" NPT	40"	18"
HIF-75	300	75	25 Triple	3" NPT	1½" NPT	42"	20"
HIF-100	400	100	50 Double	3" NPT	1½" NPT	52"	20"
HIF-150-FL	600	150	50 Triple	4" Flange	1½" NPT	48"	28"
HIF-200-FL	800	200	100 Double	4" Flange	1½" NPT	58"	28"



Cartridge Lengths: Single = 9¾", Double = 19½", Triple = 29¼"

* To order 316SS Option, add "-316SS" to the end of the part number. Example: HIF-7-316SS

Harmsco Band-Clamp Up-Flow Multi-Cartridge Housings

- 304 Stainless Steel Electro-Polished (316SS or Poly-Coated Options Available)
- Adjustable Top Plates to Accept Harmsco or Standard Length Cartridges
- Band-Clamp Closure with Buna-N O-Rings
- Pressure Rated at 150 PSI, up to 300°F (149°C)

Model No.	Rec'd Flow (GPM)	Max Flow (GPM)	Houses Cartridges		Inlet/Outlet	Dimensions	
			Qty.	Length		Height	Width
BC4-1-T-EP	12	25	4	9¾" or 10"	2" FNPT	19½"	11½"
BC4-2-T-EP	24	50	4	19½" or 20"	2" FNPT	29¼"	11½"
BC4-3-T-EP	36	75	4	29¼" or 30"	2" FNPT	39"	11½"
BC6-1-T-EP	18	42	6	9¾" or 10"	2" FNPT	25½"	12"
BC6-2-T-EP	36	84	6	19½" or 20"	2" FNPT	35¼"	12"
BC6-3-T-EP	54	126	6	29¼" or 30"	2" FNPT	45"	12"



Visit us on the web for our complete product line and in-depth technical information. www.appliedmembranes.com

APPLIED MEMBRANES INC.®

ISO 9001:2008
Certified Company

(760) 727-3711 • FX: (760) 727-4427
sales@appliedmembranes.com

AM, APPLIED MEMBRANES INC., APPLIED ARE TRADEMARKS OF APPLIED MEMBRANES, INC. © 2012

Premium Polyester and WaterBetter® Filter Cartridges

Highly Efficient Filter Cartridges made of pleated Polyester-Plus™ filter media, FDA approved materials; NSF 61 certified. Cleanable and reusable in most applications.



Applications:

- Reverse Osmosis Pre-Filtration
- Municipal Drinking Water Filtration
- Commercial/Residential Drinking Water Filtration
- Desalination Pre-filtration
- Industrial Water Filtration
- Cooling Tower Filtration
- Chill Water Loop Filtration
- Food & Beverage Filtration
- Marine/Aquatic Filtration

Premium Polyester "801" Series Filter Cartridges

Note that Premium Series Filter cartridges are available in two different size configurations: Harmsco Type will fit into Harmsco Multi-Filter Housings, while "Standard Type" will fit into single-cartridge and other housings which accept "industry standard" filter lengths. Please choose the appropriate size from the table below.

Single Length (10") Filter Cartridges

Model Numbers (Choose Type)		Nominal Micron	End Cap Color
Harmsco (9¾"L)	Standard (10"L)		
801-0.35	801-0.35/10	0.35 µ	Brown
801-1*	801-1/10	1 µ	Tan
801-5*	801-5/10	5 µ	White
801-10	n/a	10 µ	Red
801-20*	801-20/10	20 µ	Blue
801-50*	801-50/10	50 µ	Yellow
801-100	n/a	100 µ	Green

*Items marked are available with "High Temperature" option (up to 200°F/93°C). To order, add "HT" to the part # - e.g.: 801-1HT

Double Length (20") Filter Cartridges

Model Numbers (Choose Type)		Nominal Micron	End Cap Color
Harmsco (19½"L)	Standard (20"L)		
921-0.35	801-0.35/20	0.35 µ	Brown
921-1	801-1/20	1 µ	Tan
921-5	801-5/20	5 µ	White
921-10	801-10/20	10 µ	Red
921-20	801-20/20	20 µ	Blue
921-50	801-50/20	50 µ	Yellow

Triple Length (30") Filter Cartridges

Model Numbers (Choose Type)		Nominal Micron	End Cap Color
Harmsco (29¼"L)	Standard (30"L)		
931-0.35	801-0.35/30	0.35 µ	Brown
931-1	801-1/30	1 µ	Tan
931-5	801-5/30	5 µ	White
931-10	801-10/30	10 µ	Red
931-20	801-20/30	20 µ	Blue
931-50	801-50/30	50 µ	Yellow

40" Length Filter Cartridges (Standard Style)

Model Numbers	Nominal Micron	End Cap Color
801-0.35/40	0.35 µ	Brown
801-1/40	1 µ	Tan
801-5/40	5 µ	White
801-10/40	10 µ	Red
801-20/40	20 µ	Blue
801-50/40	50 µ	Yellow

WaterBetter® Economically Priced Filter Cartridges

Harmsco WaterBetter Cartridges are available in Single, Double and Triple Length, and can be used in Harmsco Multi-Cartridge Filters, or as replacements for "standard" filter cartridges. Choose correct length in the table below.

Model Numbers (Please Choose Correct Length)				Nominal Micron	End Cap Color
Single (9¾"L) Harmsco or Std. Housing	Double (19½"L) Harmsco Only	20" Standard (20"L) Standard/Non-Harmsco	Triple (29¼"L) Harmsco or Std. Housing		
WB-1	WB-921-1	WB-20-1W	WB-931-1	1 µ	Tan
WB-5	WB-921-5	WB-20-5W	WB-931-5	5 µ	White
WB-20	WB-921-20	WB-20-20W	WB-931-20	20 µ	Blue
WB-50	WB-921-50	WB-20-50W	WB-931-50	50 µ	Yellow

Visit us on the web for our complete product line and in-depth technical information. www.appliedmembranes.com

Poly-Pleat™, All-Poly & SureSafe™ Filter Cartridges

Poly-Pleat Absolute Rated Filter Cartridges

- Absolute rated one micron filter media removes cyst-sized particles for safe drinking water. Substantially removes: Cryptosporidium, Giardia Cysts, Harmful Organisms, Sediment, Silt, Turbidity and more.
- Constructed of FDA Listed Materials, NSF/ANSI 61 Certified
- Maximum Temperature: 140°F/60°C
- Micron Rating: 1µ Absolute
- Flow Rate: Up to 0.5 gpm per Square Foot of Media



Model No.	Size	Fits Housings		Dimensions		Media (Sq. Ft.)
		Harmsco HIF Style	Std. Single Cartridge	Length	O.D.	
<i>Standard Cartridges for use in Harmsco or Standard Filter Housings</i>						
PP-S-1	Single/ 10" Std.	✓	✓	9¾"	2¾"	3.7
PP-D-1	Double	✓	--	19½"	2¾"	7.5
PP-20E-1	20" Standard	--	✓	20"	2¾"	7.5
PP-T-1	Triple/ 30" Std.	✓	✓	29¼"	2¾"	11
<i>Calypso Blue™ Cartridges for Replacement in "Big Blue" Filter Housings</i>						
PP-BB-10-1	10" Big Blue	--	✓ (BB)	9¾"	4½"	8.0
PP-BB-20-1	20" Big Blue	--	✓ (BB)	20"	4½"	16.8

All-Poly High Purity Absolute Rated Filter Cartridges

- High Flow Absolute Rated Filters Constructed of 100% Polypropylene Media with Polypropylene End caps and Components
- Double Open Ended (Flat Gasket) End Cap Configuration (222, 226, 213 end caps also available)

Model Numbers (Please Choose Correct Length)				Absolute Micron
Single (9 ¾"L) Harmsco or Std. Housing	Double (19 ½"L) Harmsco Only	20" Standard (20"L) Standard/Non-Harmsco	Triple (29 ¼"L) Harmsco or Std. Housing	
PP-975-0.2-DOE	PP-195-0.2-DOE	PP-20-0.2-DOE	PP-2925-0.2-DOE	0.2 µ
PP-975-0.45-DOE	PP-195-0.45-DOE	PP-20-0.45-DOE	PP-2925-0.45-DOE	0.45 µ
PP-975-1-DOE	PP-195-1-DOE	PP-20-1-DOE	PP-2925-1-DOE	1 µ
PP-975-5-DOE	PP-975-5-DOE	PP-20-5-DOE	PP-2925-5-DOE	5 µ

SureSafe™ Antimicrobial Filter Cartridges

Model No.	Nominal Micron Rating	Size	Fits Housings		Dimensions		Media (Sq. Ft.)
			Harmsco HIF Style	Std. Single Cartridge	Length	O.D.	
<i>Standard Cartridges for use in Harmsco or Standard Filter Housings</i>							
801-20-AM	20 µ	Single/ 10" Std.	✓	✓	9¾"	2¾"	6
801-50-AM	50 µ	Single/ 10" Std.	✓	✓	9¾"	2¾"	6
<i>Calypso Blue™ Cartridges for Replacement in "Big Blue" Filter Housings</i>							
HB-10-20W-AM	20 µ	10" Big Blue	--	✓ (BB)	9¾"	4½"	12
HB-10-50W-AM	50 µ	10" Big Blue	--	✓ (BB)	9¾"	4½"	12
HB-20-20W-AM	20 µ	20" Big Blue	--	✓ (BB)	20"	4½"	26
HB-20-50W-AM	50 µ	20" Big Blue	--	✓ (BB)	20"	4½"	26

Visit us on the web for our complete product line and in-depth technical information. www.appliedmembranes.com

HARMSCO® Filtration Products



Hurricane® Single-Cartridge Filter Housings

HARMSCO HP Hurricane® Filter Housings

- Combination Cyclone Separator and Cartridge Filter
- Electropolished 304 Stainless Steel (316 SS option available*)
- Fail-Safe Lids with Individual Studs and Brass Wing Nuts
- CPVC Standpipe for Up-Flow Design
- Pressure Rated to 150 PSI, Temperature Rated to 140°F
- 2" NPT Pipe Connection, 1" NPT Drain

Model No.	Max Flow* (GPM)	Fits Cartridge	Dimensions		
			Height	Floor Space	Service Height
HUR-40-HP	50	HUR-40	19½"	15" x 15"	35"
HUR-90-HP	100	HUR-90	29⅞"	15" x 15"	52"
HUR-170-HP	150	HUR-170	40½"	15" x 15"	72"

* To order in 316SS, add "-316" to the part number. Example: HUR-40-HP-316

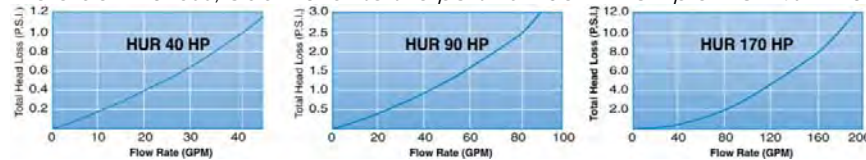

WaterBetter® Economy-Priced Hurricane-Style Housings

- Electropolished 304 Stainless Steel (316SS option available*)
- Fail-Safe Lids with Brass Wing Nuts
- CPVC Standpipe (SS available upon request)
- Pressure rated to 150 PSI, Temperature rated to 140°F
- 2" NPT Pipe Connection, 1" NPT Drain (1" Pipe Size available)

Model No.	Max Flow* (GPM)	Fits Cartridge	Dimensions		
			Height	Floor Space	Service Height
WB-40SC-2	50	HUR-40	19¼"	15" x 15"	31"
WB-90SC-2	100	HUR-90	29⅞"	15" x 15"	51"
WB-170SC-2	150	HUR-170	39⅞"	15" x 15"	72"

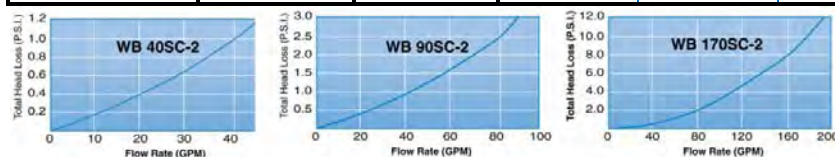

* To order in 316SS, add "-316" to the part number. Example WB-40SC-2-316



WaterBetter® High Capacity Multi-Hurricane Housing

- The Harmsco WB 5x170FL Houses (5) HUR170
- Pressure Rated up to 125psi, Temperature rated to 140°F.
- 4" Flange Pipe Connection, 1½" NPT Drain

Model No.	Max Flow* (GPM)	Fits Cartridges	Dimensions		
			Height	Floor Space	Service Height
WB-5x170FL	750	5xHUR-170	46"	28" x 28"	72"

*Flows rates above are guidelines for housing capacity only. Actual flow rates will depend on filter cartridge type, water quality, and other factors.



Visit us on the web for our complete product line and in-depth technical information. www.appliedmembranes.com



(760) 727-3711 • FX: (760) 727-4427
sales@appliedmembranes.com

AM, APPLIED MEMBRANES INC., APPLIED ARE TRADEMARKS OF APPLIED MEMBRANES, INC. © 2012

Filter Cartridges for Hurricane & WaterBetter Housings

Pleated Polyester Filter Cartridges

- For Sediment Removal & Turbidity Reduction
- Cartridges are Cleanable and Reusable in Most Applications
- Cartridges Operate in pH of 3 to 11 and Temperatures to 140°F (60°C)
- Come in 3 sizes to Fit Hurricane-style Housings, Choose Correct Size from Table

Model No. (Choose Filter Size)			Nominal Micron Rating
Size 40 (HUR-40) (7¾" OD×9⅝" L)	Size 90 (HUR-90) (7¾" OD×19½" L)	Size 170 (HUR-170) (7¾" OD×30¾" L)	
HC/40-0.35	HC/90-0.35	HC/170-0.35	0.35 μ
HC/40-1	HC/90-1	HC/170-1	1 μ
HC/40-5	HC/90-5	HC/170-5	5 μ
HC/40-10	HC/90-10	HC/170-10	10 μ
HC/40-20	HC/90-20	HC/170-20	20 μ
HC/40-50	HC/90-50	HC/170-50	50 μ
HC/40-100	HC/90-100	HC/170-100	100 μ
HC/40-150	HC/90-150	HC/170-150	150 μ
HC/40-EZ-CLEAN	HC/90-EZ-CLEAN	HC/170-EZ-CLEAN	Cleaning Cartridge

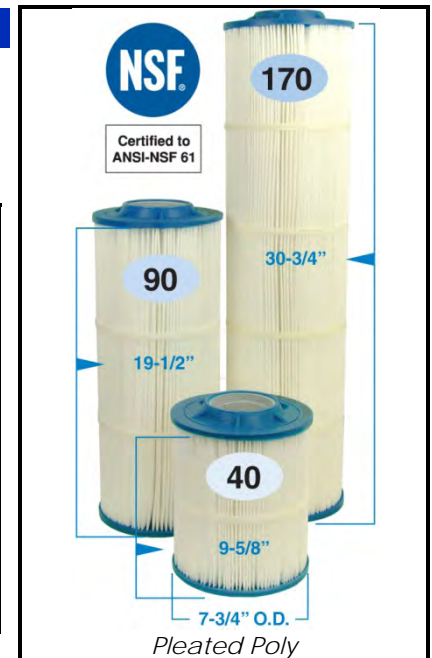

Poly-Pleat Absolute Rated Filters

- 1 Micron Absolute for Cryptosporidium and Giardia Cysts; Sediment Removal & Turbidity Reduction
- 140°F (60°C) Temperature Limit (*Varies depending on pressure and time under load*)

Model No.	Size (For Housing)
PP-HC/40-1	HUR-40
PP-HC/90-1	HUR-90
PP-HC/170-1	HUR-170

All-Poly High Purity 100% Polypropylene Media

- High Flow Absolute Rated Filters Constructed of 100% Polypropylene Media with Polypropylene End Caps and Components

Model No. (Choose Filter Size)			Nominal Micron Rating
Size 40 (HUR-40) (7¾" OD×9⅝" L)	Size 90 (HUR-90) (7¾" OD×19½" L)	Size 170 (HUR-170) (7¾" OD×30¾" L)	
HC-PP-40-0.2	HC-PP-90-0.2	HC-PP-170-0.2	0.2 μ
HC-PP-40-0.45	HC-PP-90-0.45	HC-PP-170-0.45	0.45 μ
HC-PP-40-1	HC-PP-90-1	HC-PP-170-1	1 μ
HC-PP-40-5	HC-PP-90-5	HC-PP-170-5	5 μ



All-Poly

Recommended Flow Rates:

- HC/40: 35 GPM (Max. 50)
- HC/90: 70 GPM (Max. 100)
- HC/170: 105 GPM (Max. 150)
- HC-PP-40: 17 GPM (Max. 25)
- HC-PP-90: 35 GPM (Max. 50)
- HC-PP-170: 60 GPM (Max. 100)
- HC/40-AM: 35 GPM (Max. 50)
- HC/90-AM: 70 GPM (Max. 100)
- HC/170-AM: 105 GPM (Max. 150)

SureSafe™ Antimicrobial Filters for Hurricane Housings

- Reduces Growth of Bacteria and Mold on Media

Model No. (Choose Filter Size)			Nominal Micron Rating
Size 40 (HUR-40) (7¾" OD×9⅝" L)	Size 90 (HUR-90) (7¾" OD×19½" L)	Size 170 (HUR-170) (7¾" OD×30¾" L)	
HC/40-20-AM	HC/90-20-AM	HC/170-20-AM	20 μ
HC/40-50-AM	HC/90-50-AM	HC/170-50-AM	50 μ

Visit us on the web for our complete product line and in-depth technical information. www.appliedmembranes.com